

D15 Pressure switch

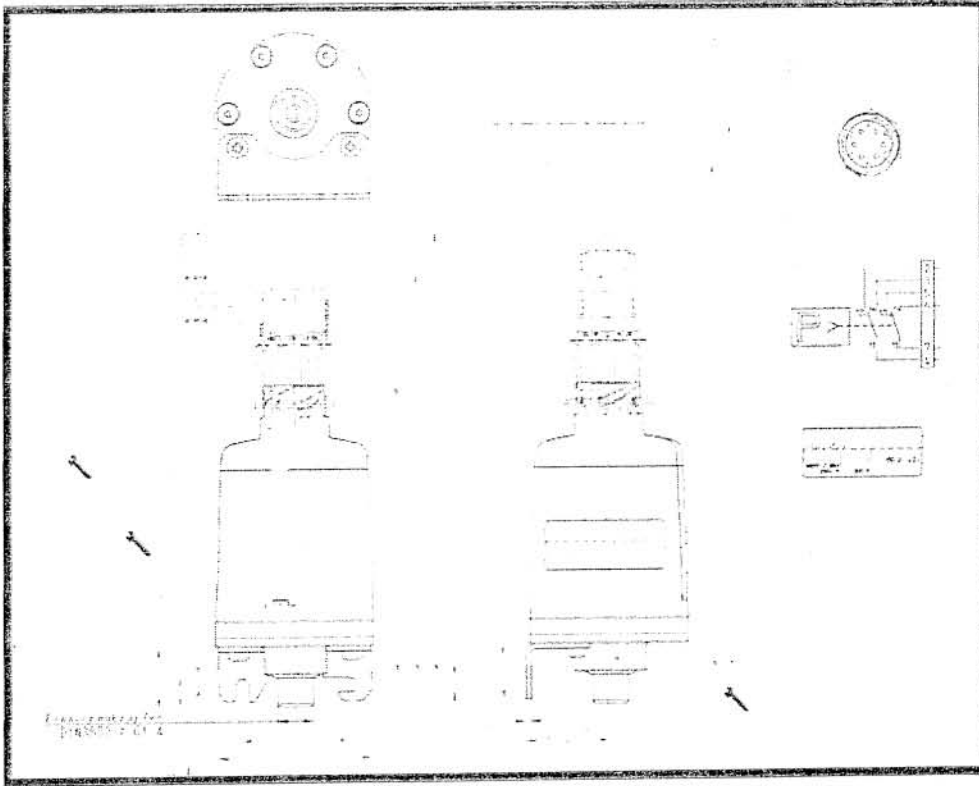

D16 Braking hose assembly

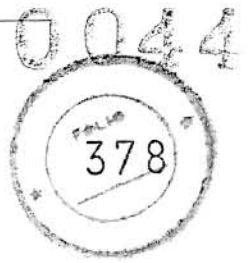
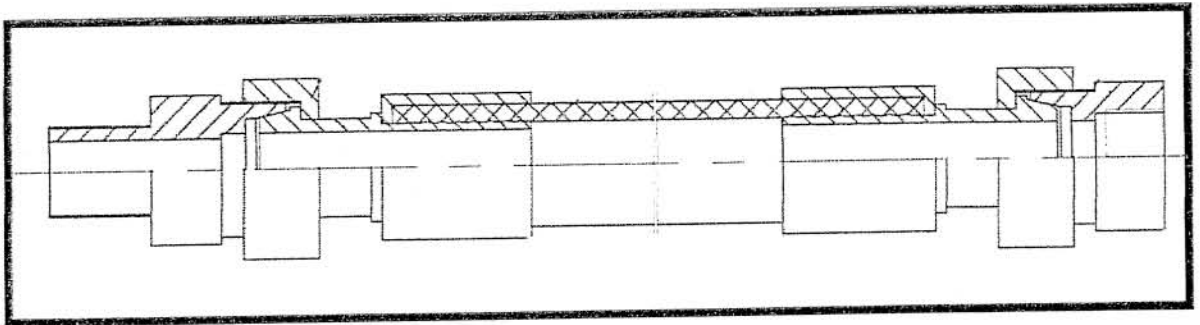

0044

D17 Magnet valve

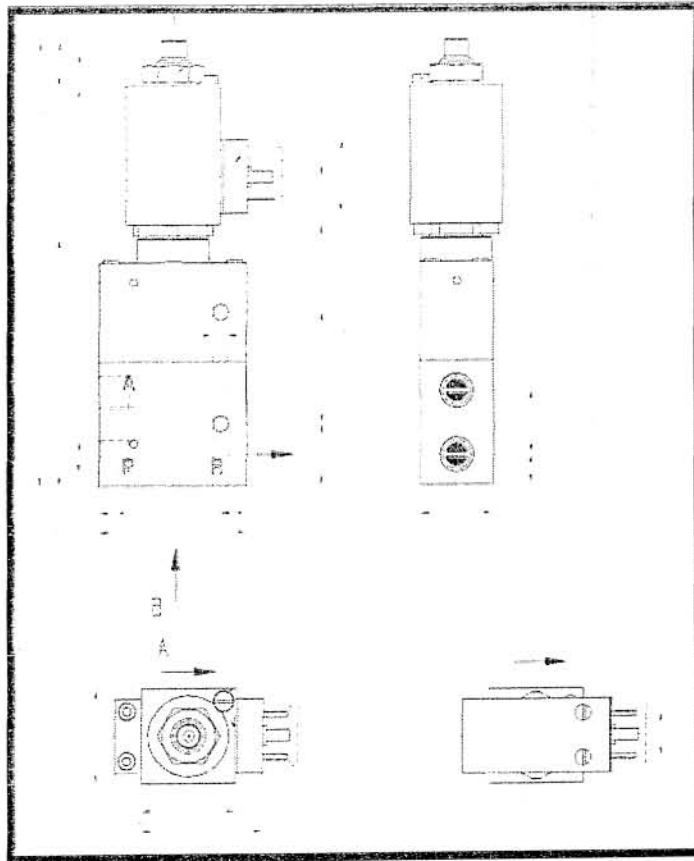

D18 Press. reduc. Valve assembly

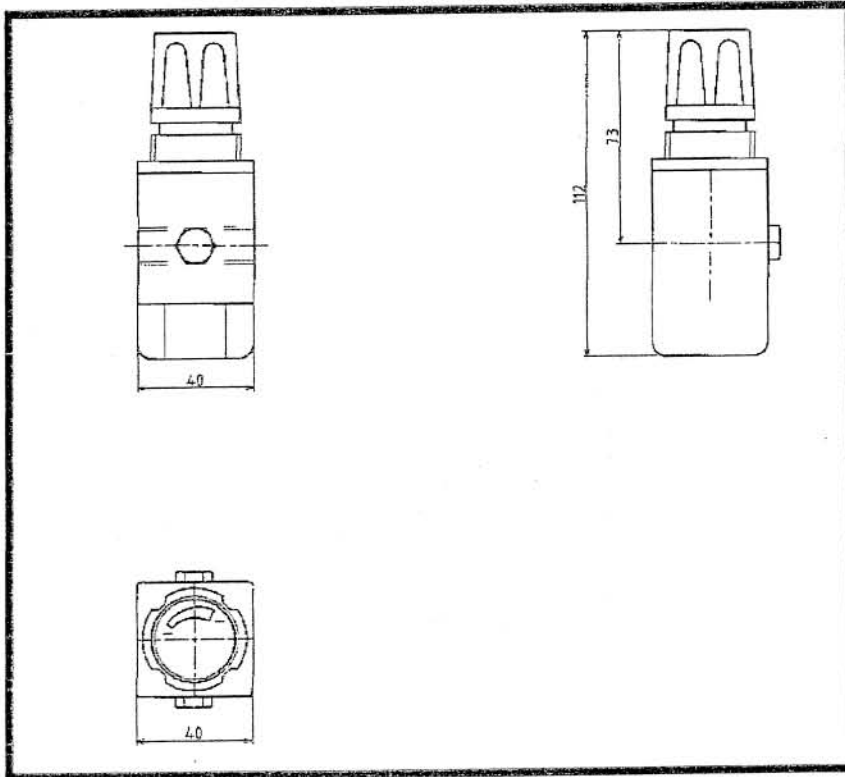

0044

D19 Gauge

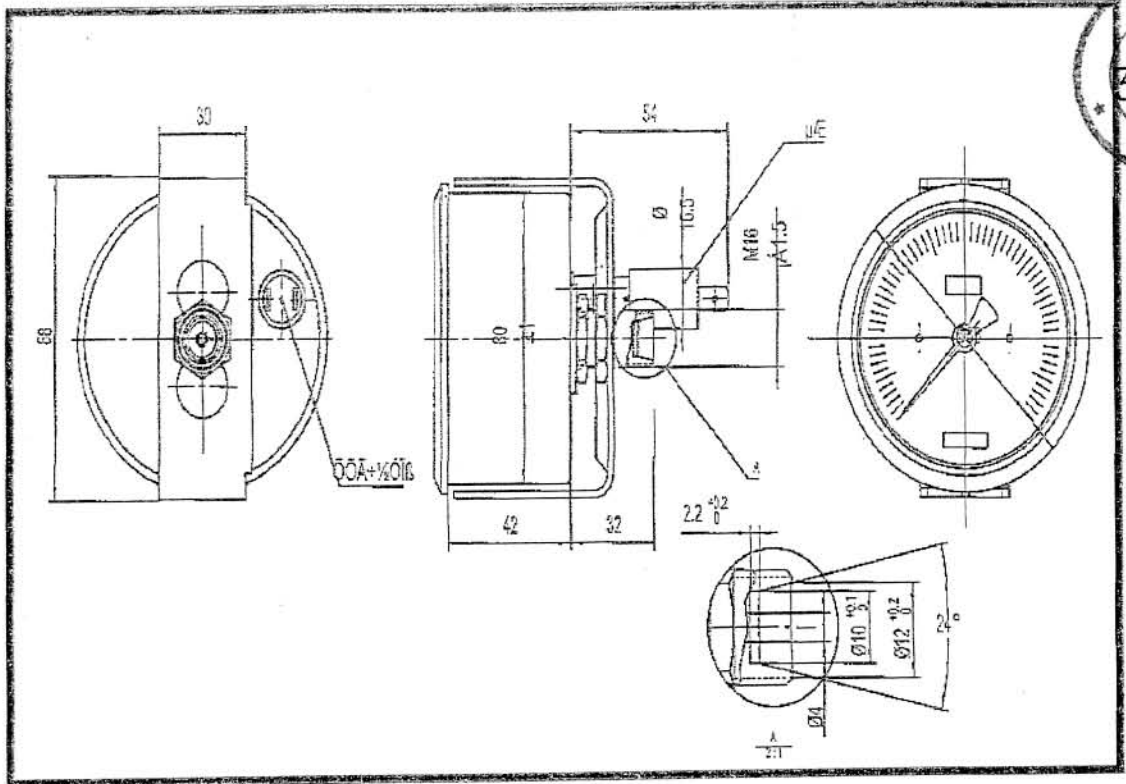

D20 Duplex gauge

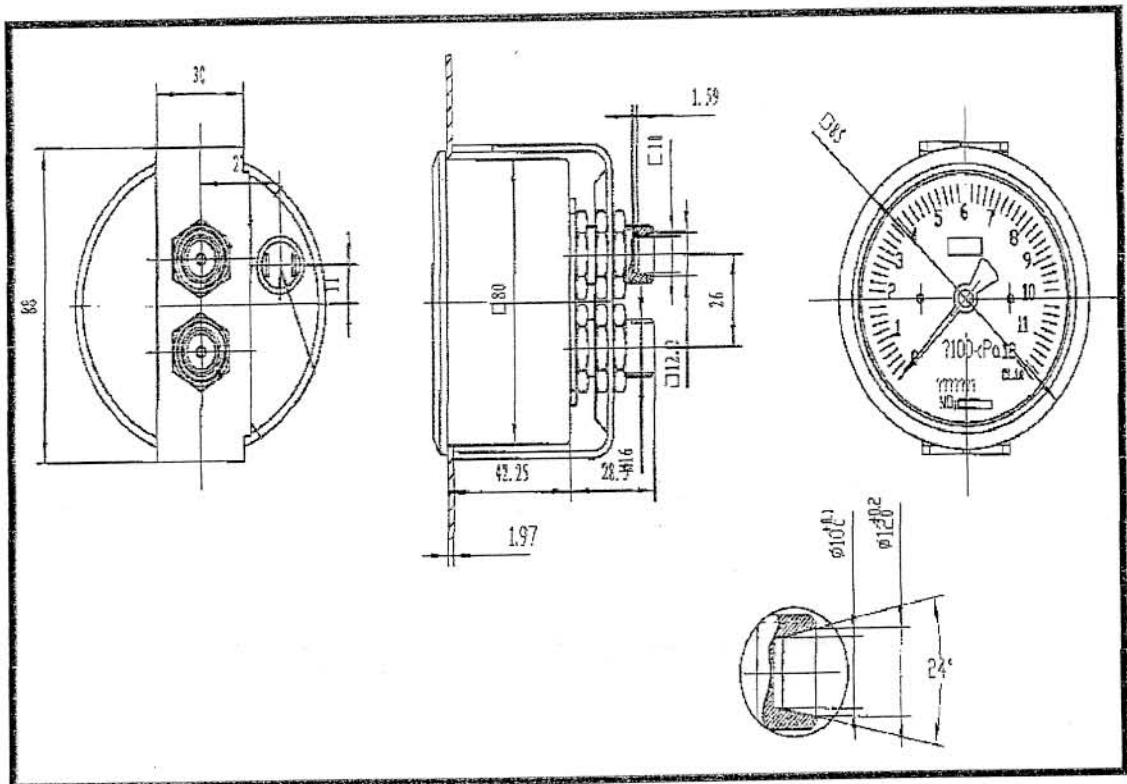

0044

D21 Wheel-M. brake disc

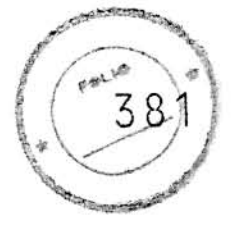
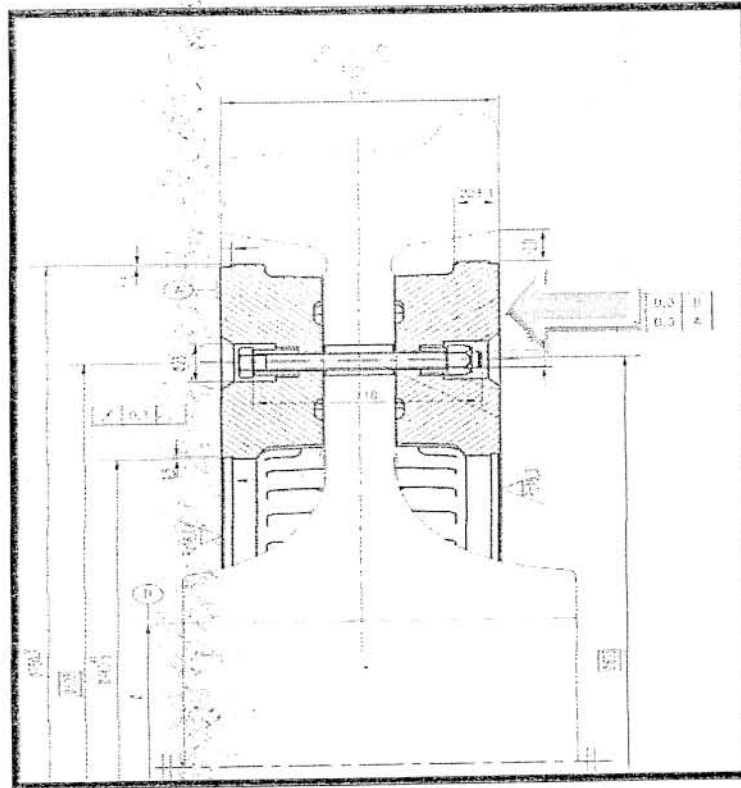

D22 Dragline assembly for manual release

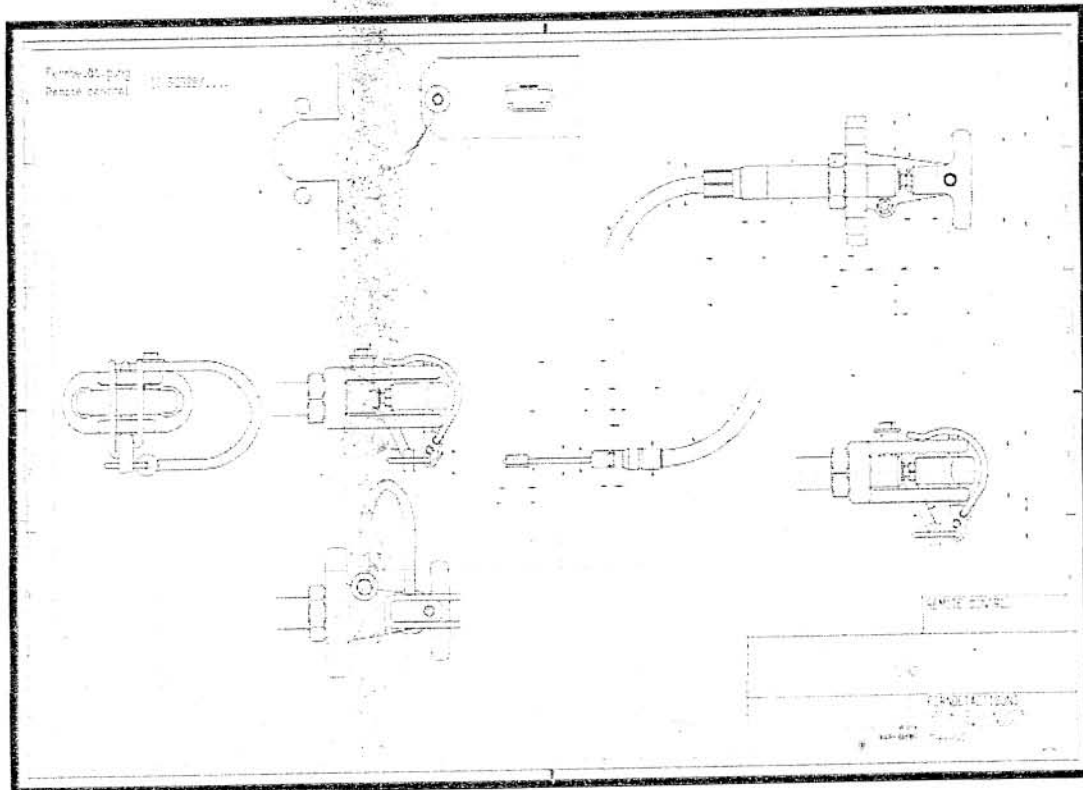



D25 Overflow valve

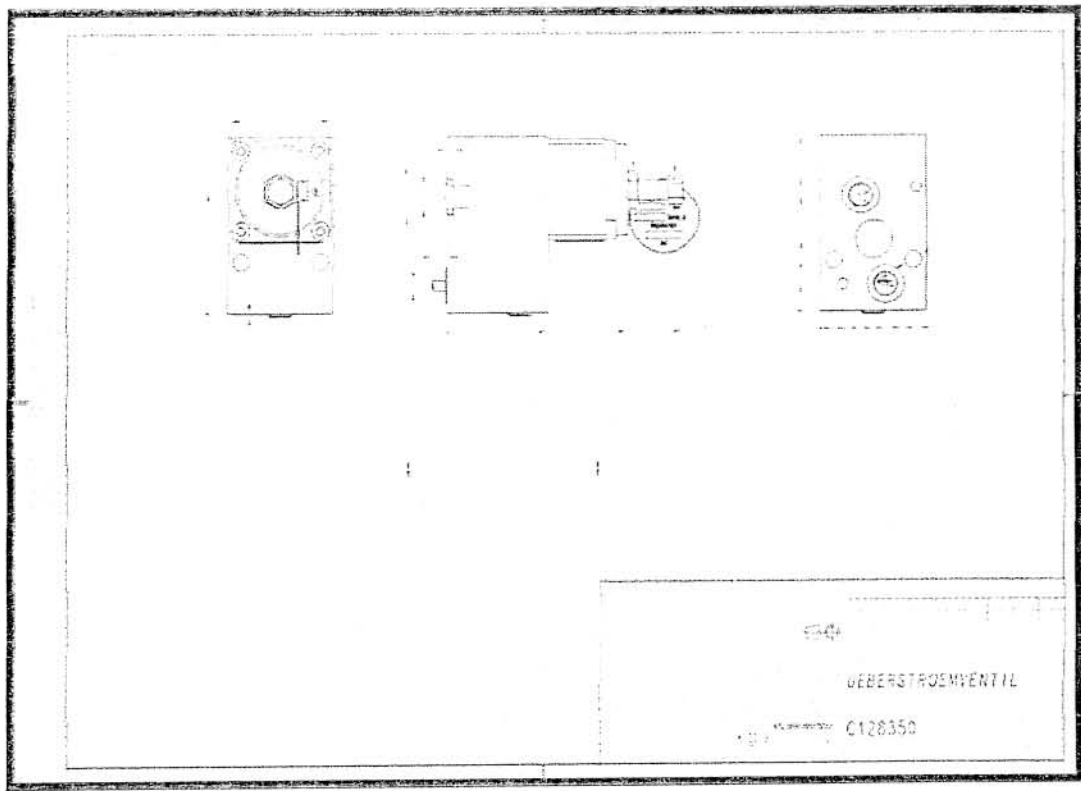
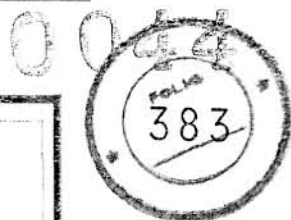

D26 Mean-Press. Valve

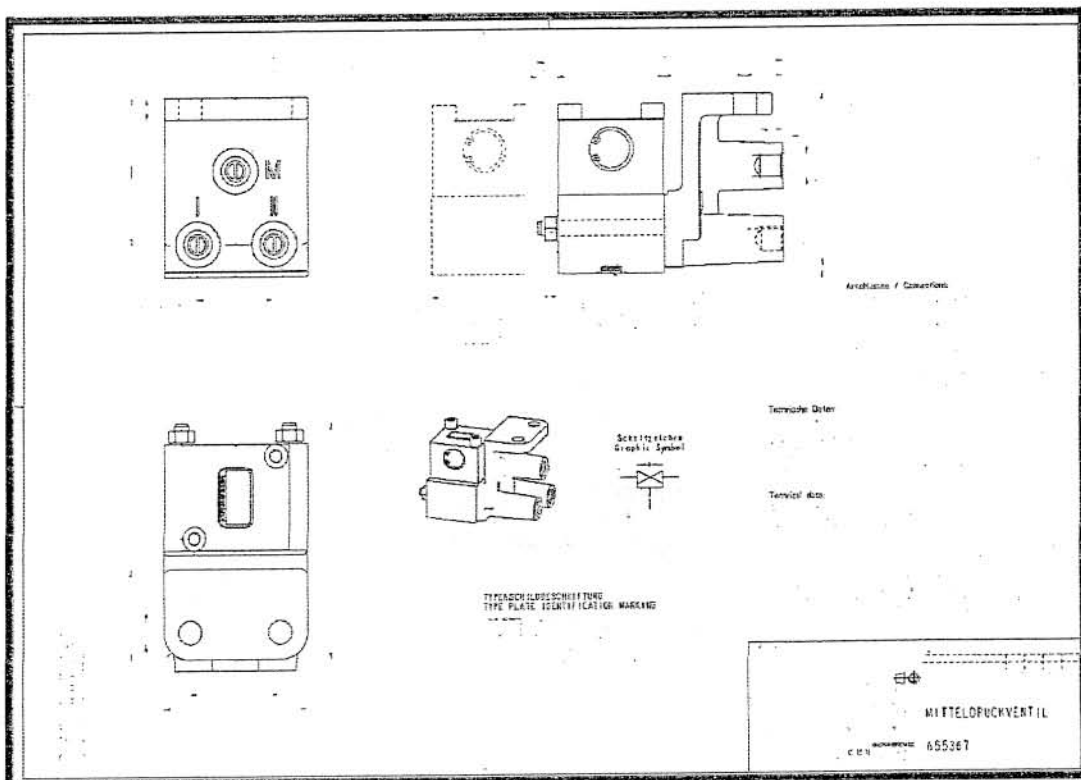

D29 Windshield wiper

0044
FOLIO
385

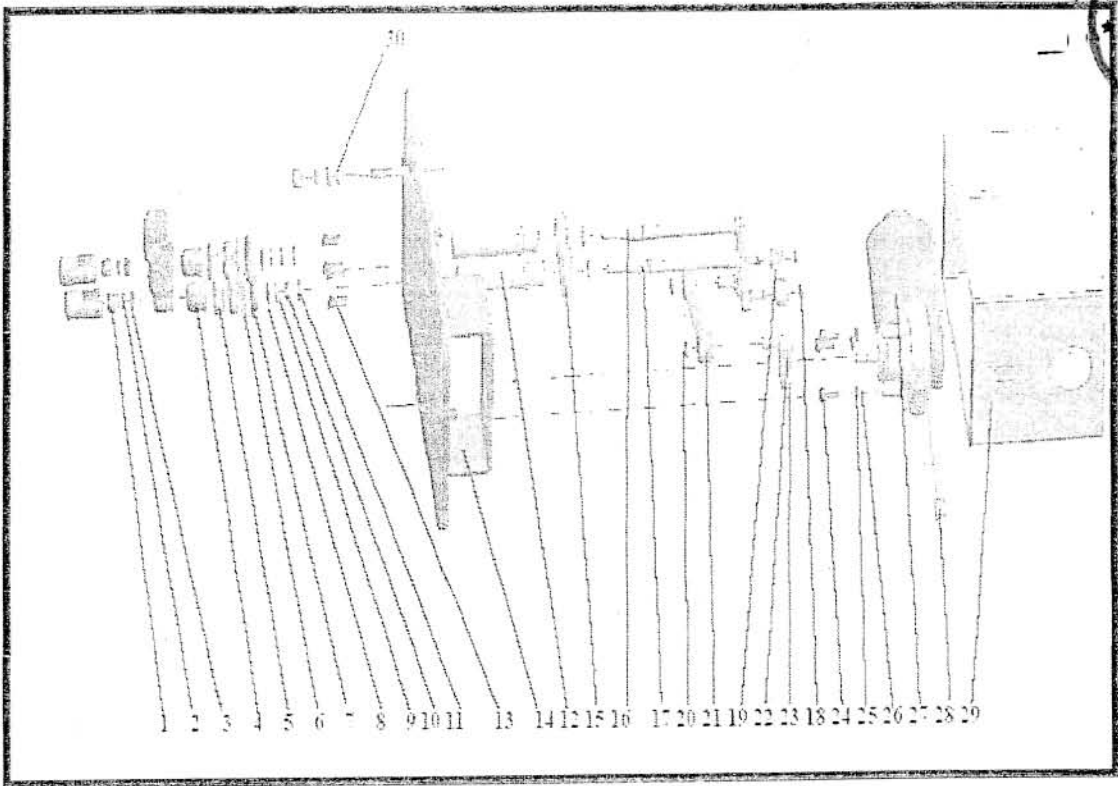

D30 Compressor set

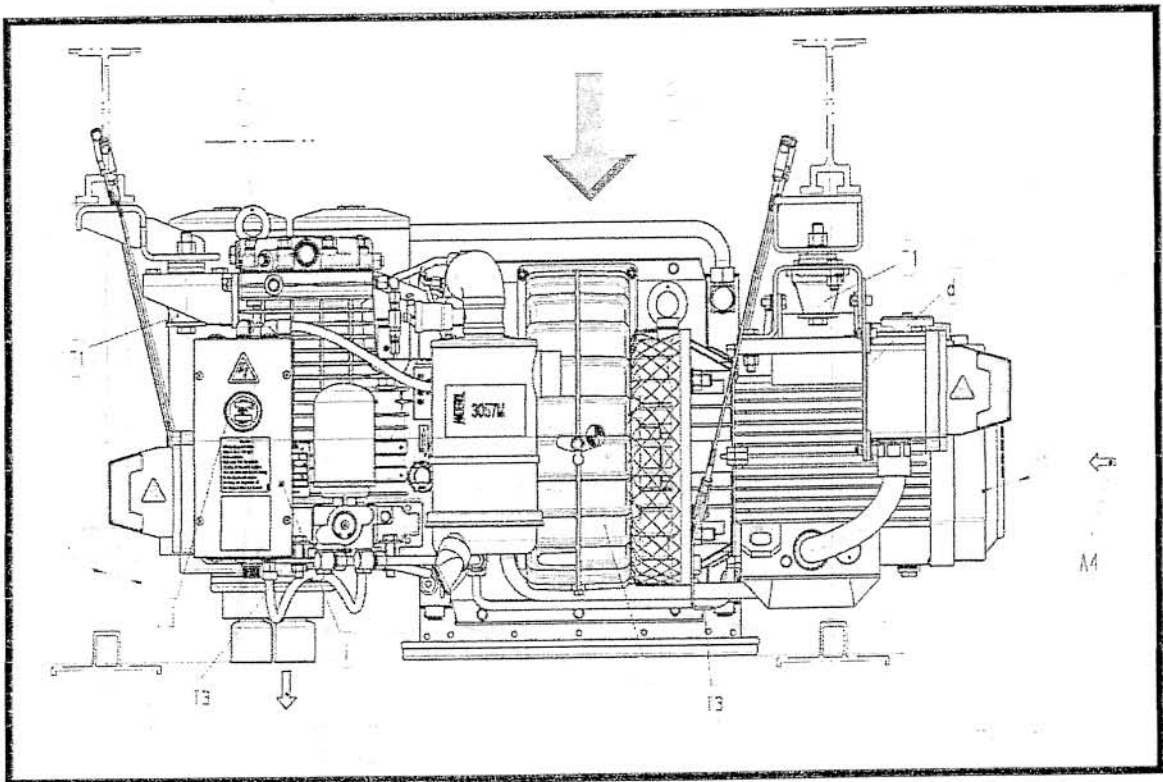

0044
★
FOLIO
386
★

D31 Pressure governor

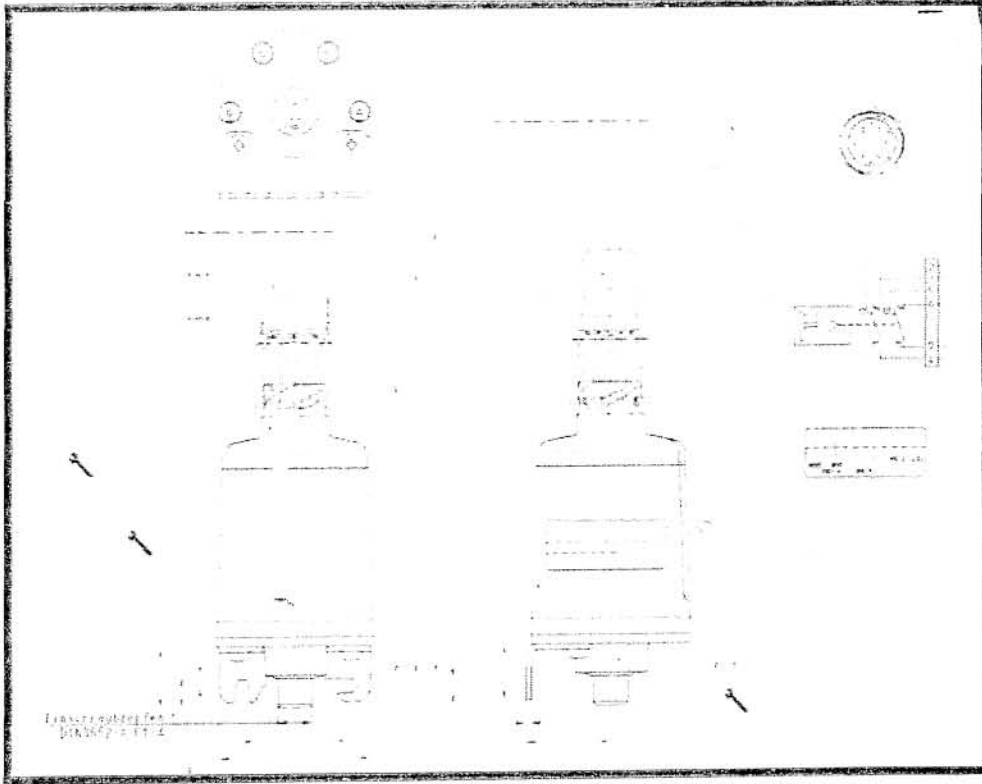

D32 Test fitting

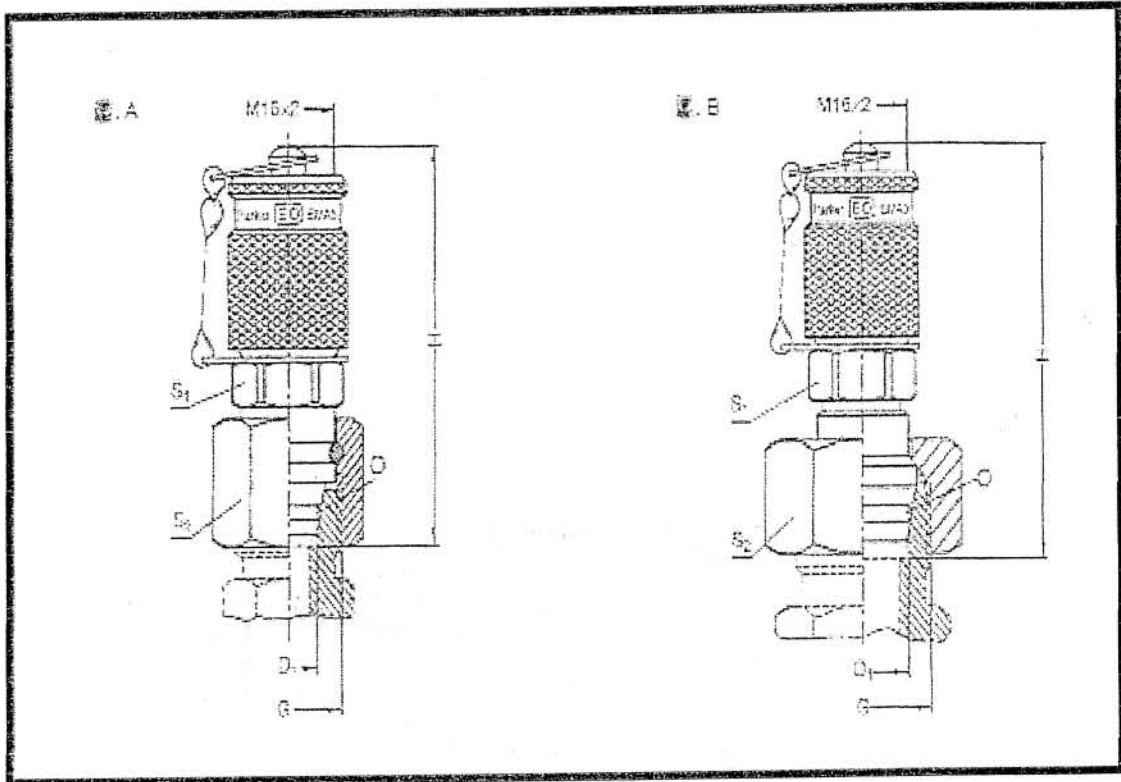

D33 3/8" drain cock

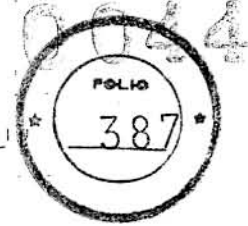
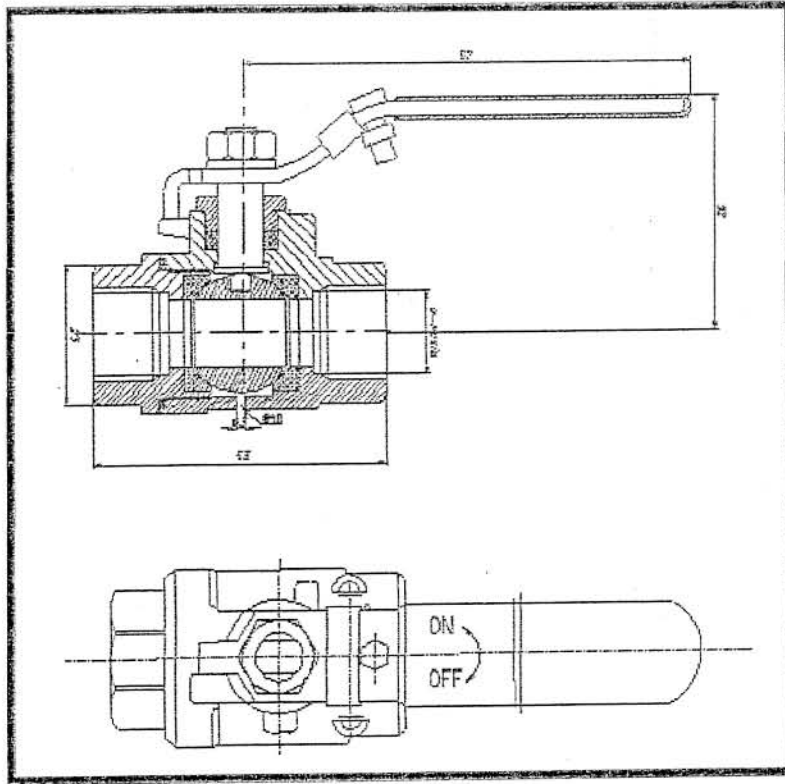

D34 Speed sensor

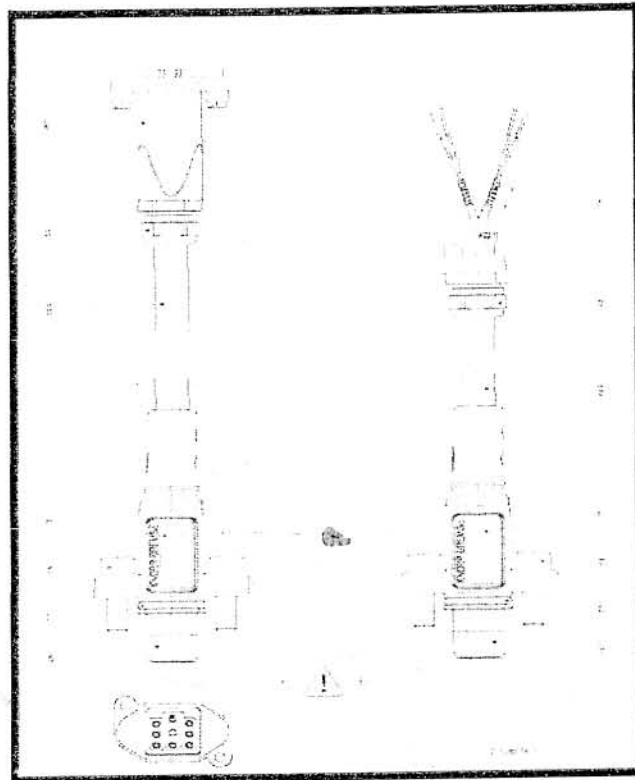

D37 Ball cock

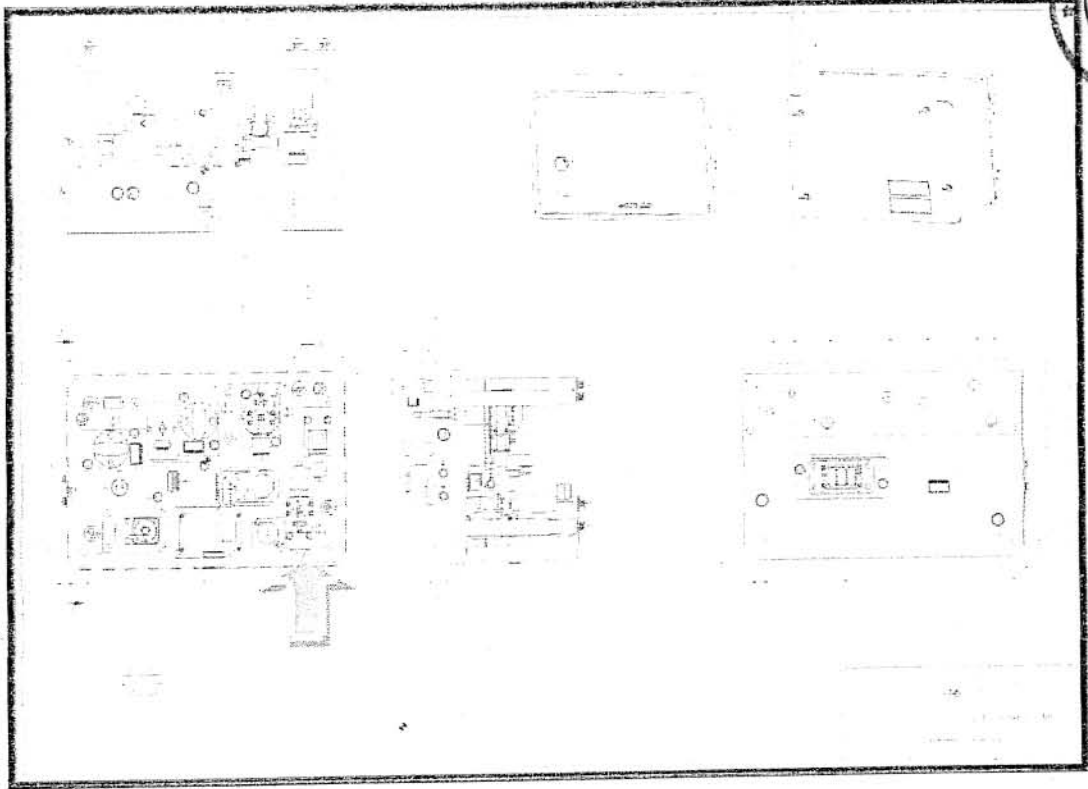
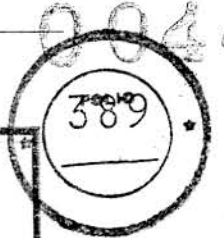

D38 Ball cock

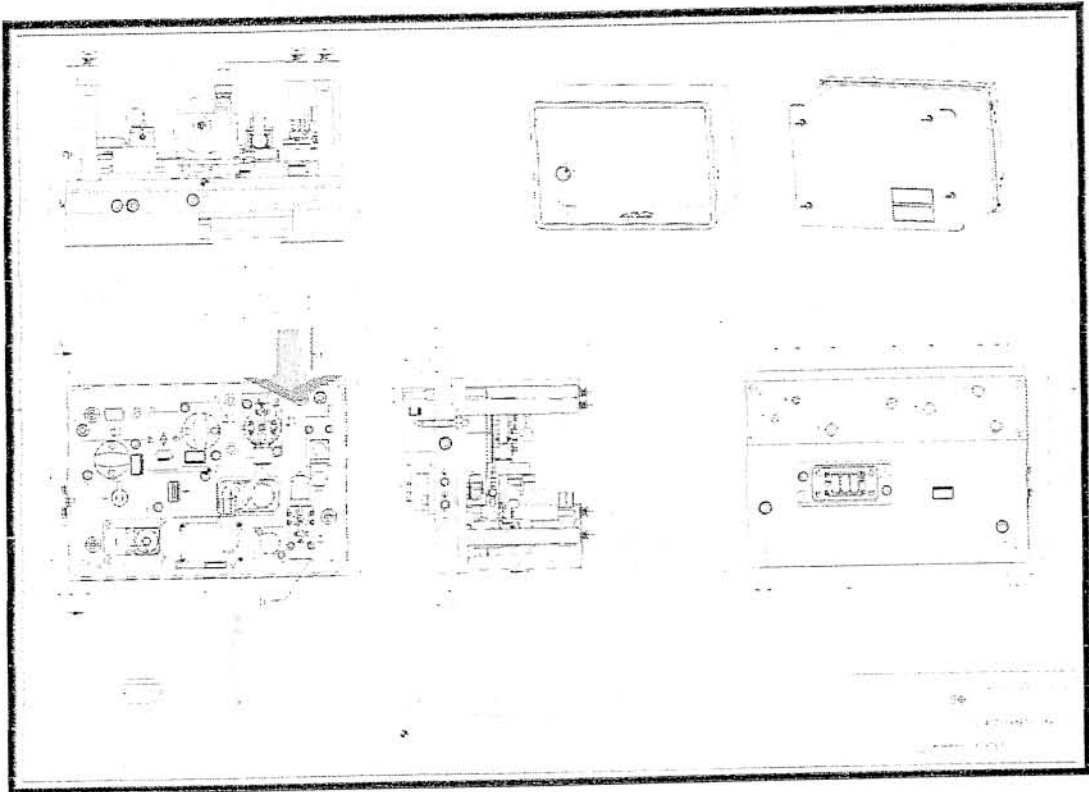

D39 Overflow valve

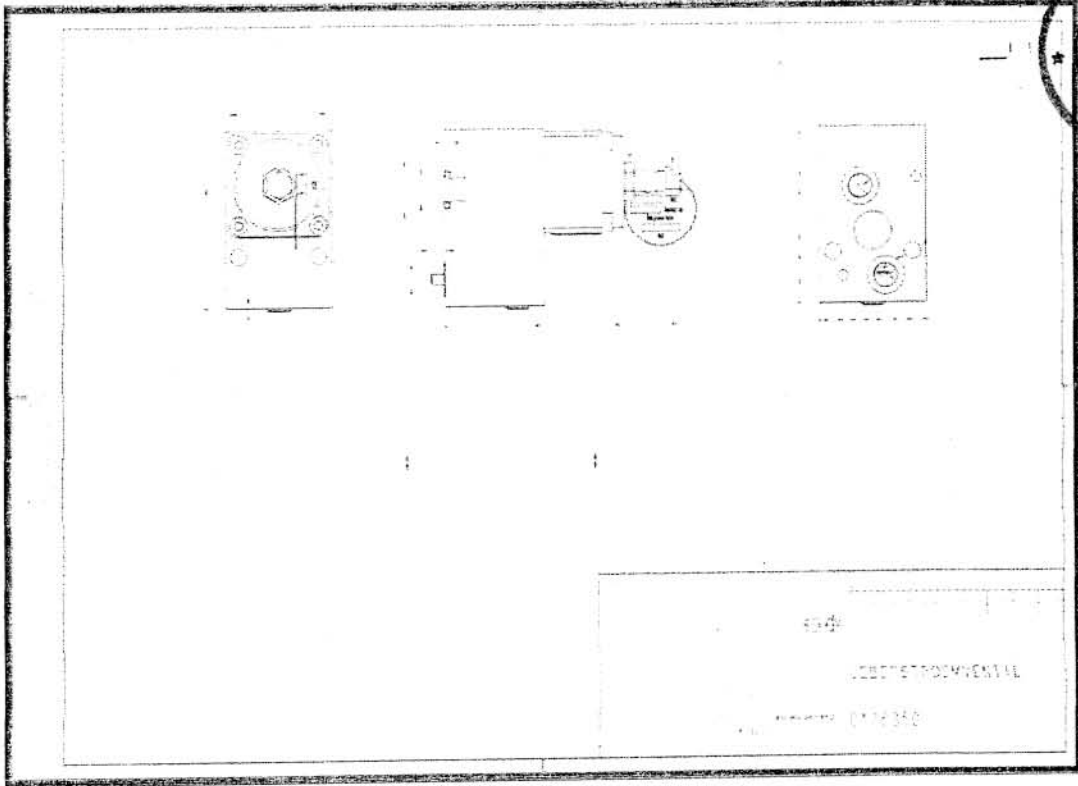

D40 Test fitting

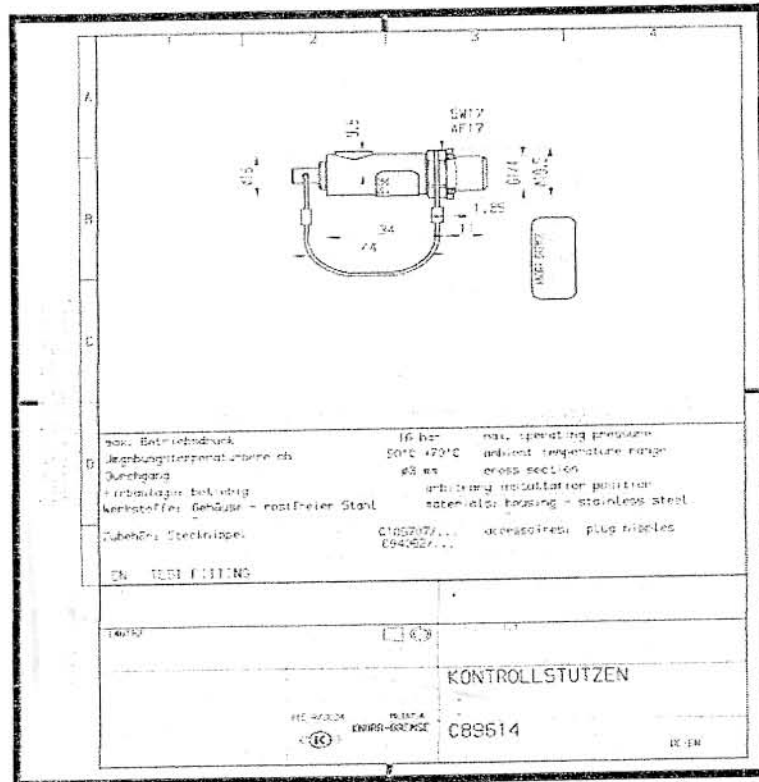

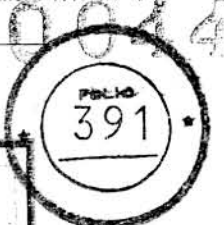

D41 Test fitting

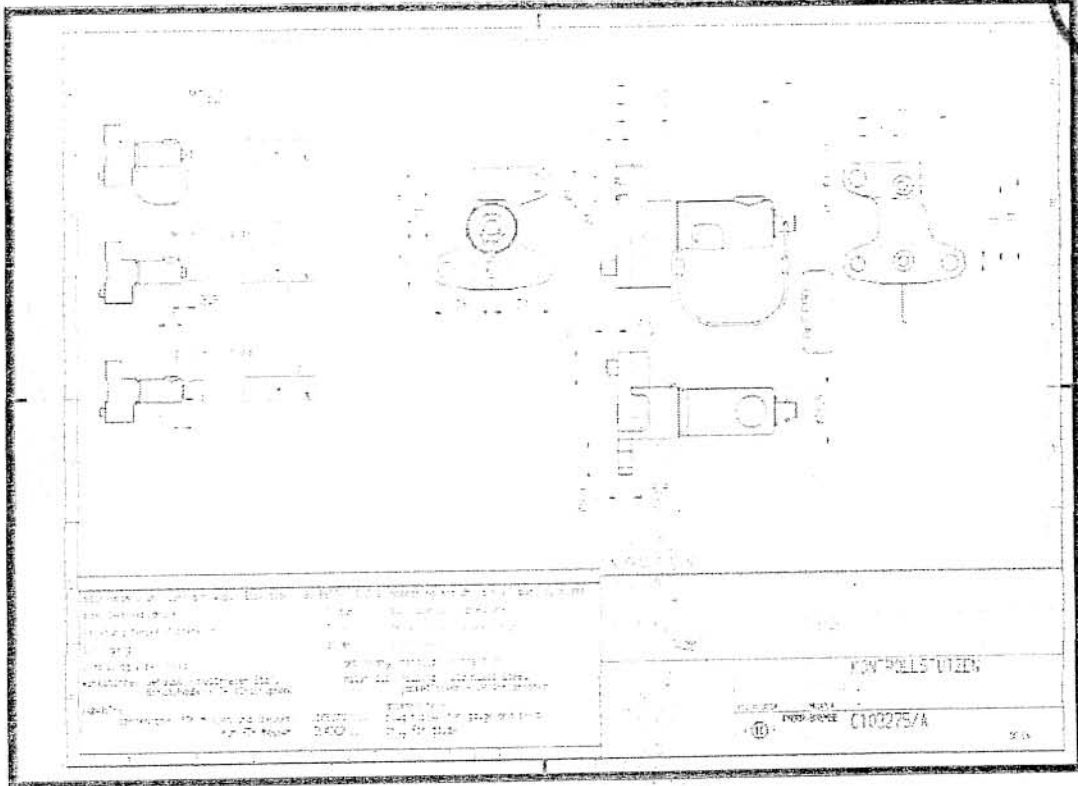

D42 Pressure governor

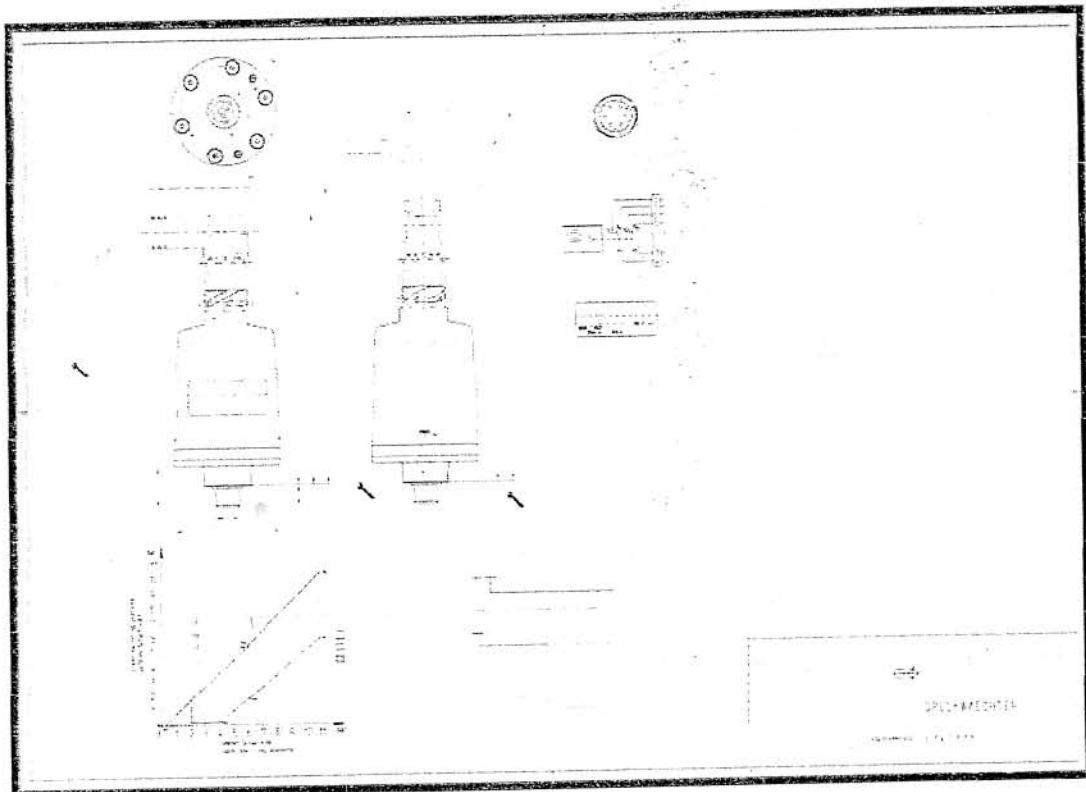



D43 Brake control unit

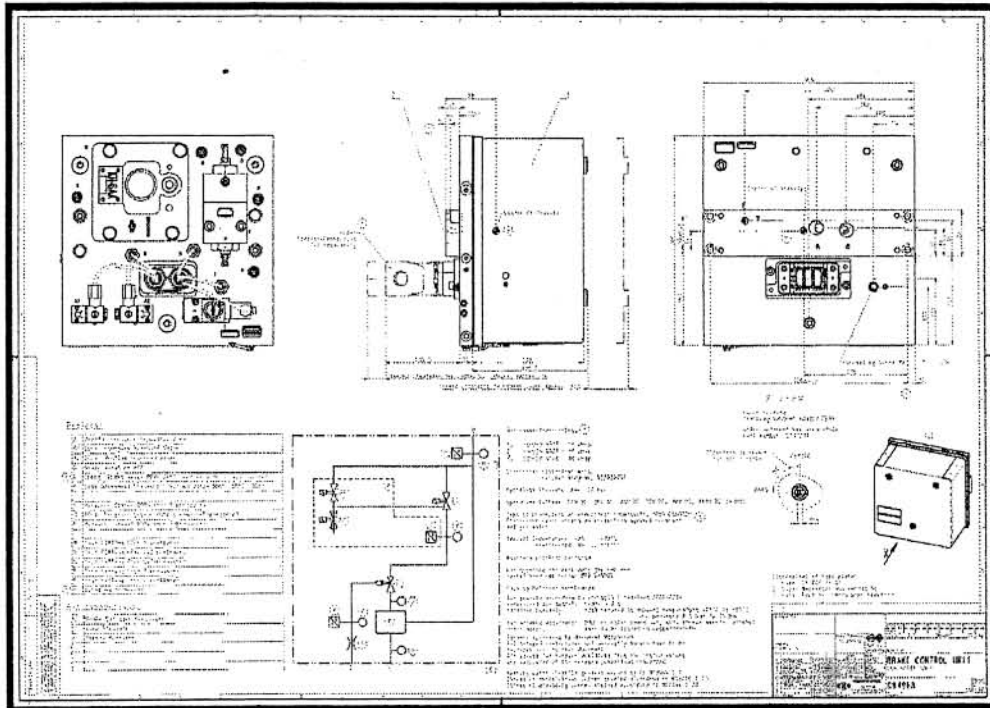

D44 Brake microcomputer control unit

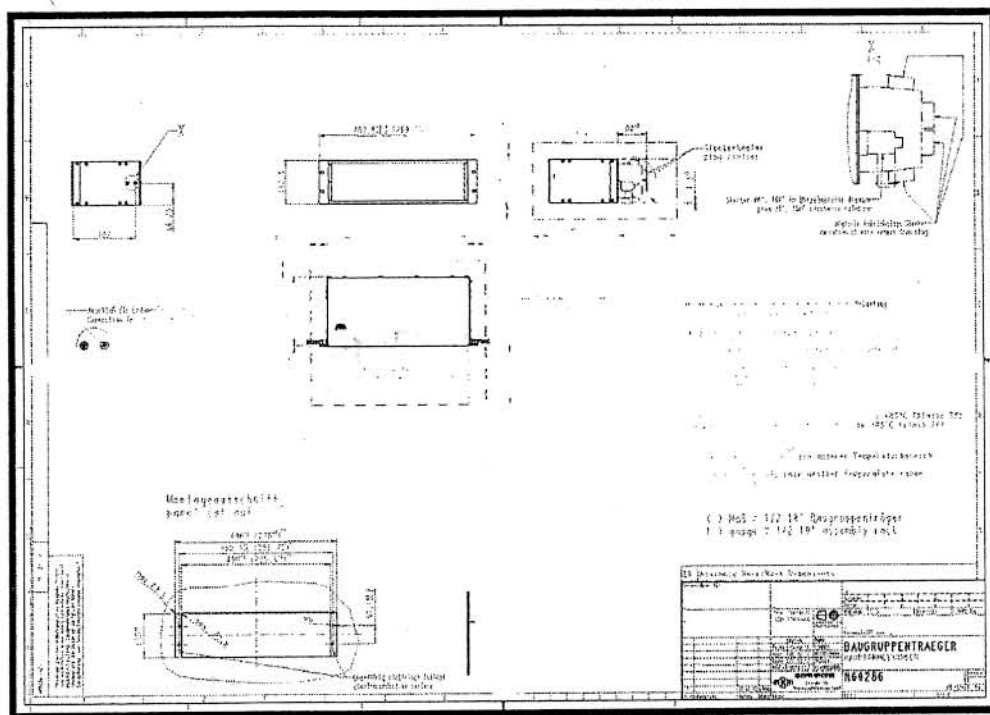

Handwritten mark resembling a stylized 'Z' or '8'.

Handwritten signature or mark.

0044

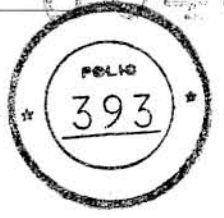

D45 1/2 cutout cock

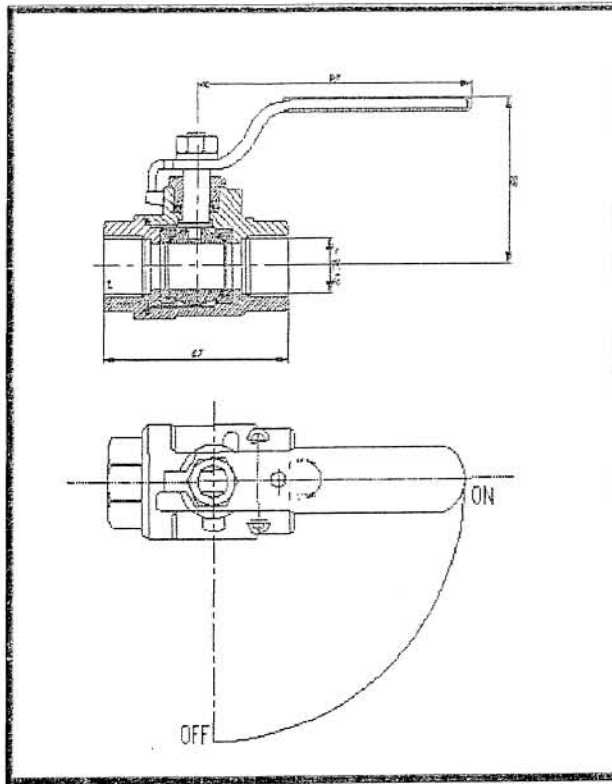

D46 3/4" electric contact cutout cock (with air exhausting side)

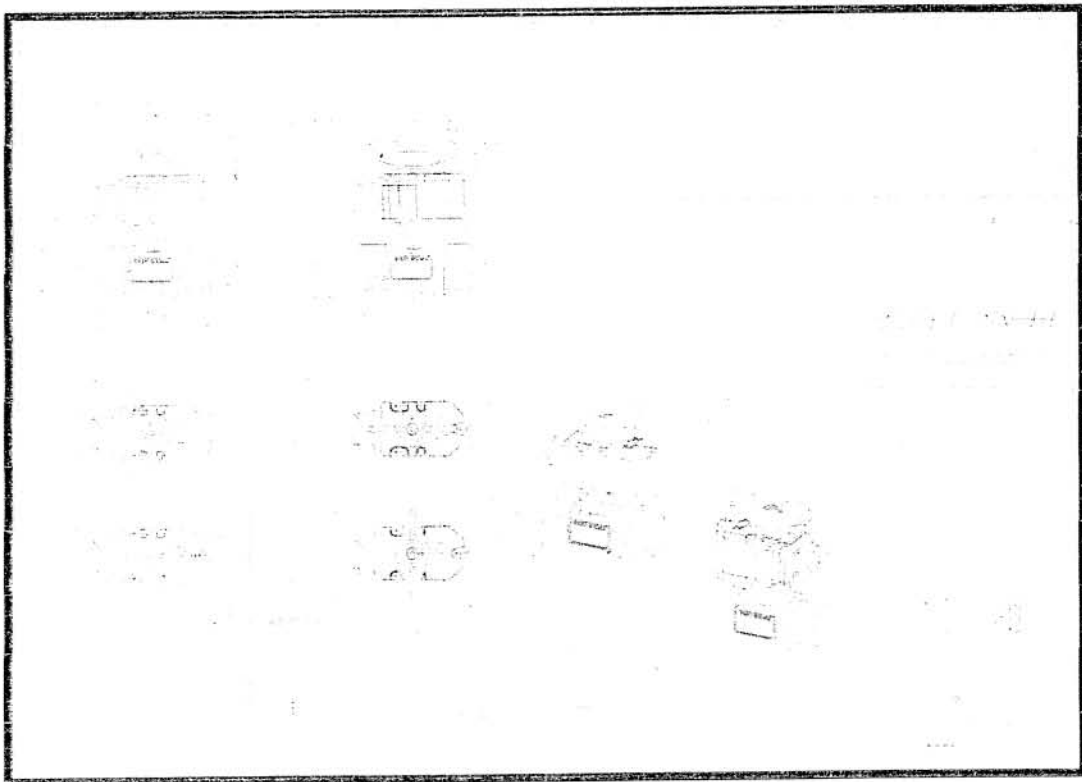



D47 Bali cock SK-DN8

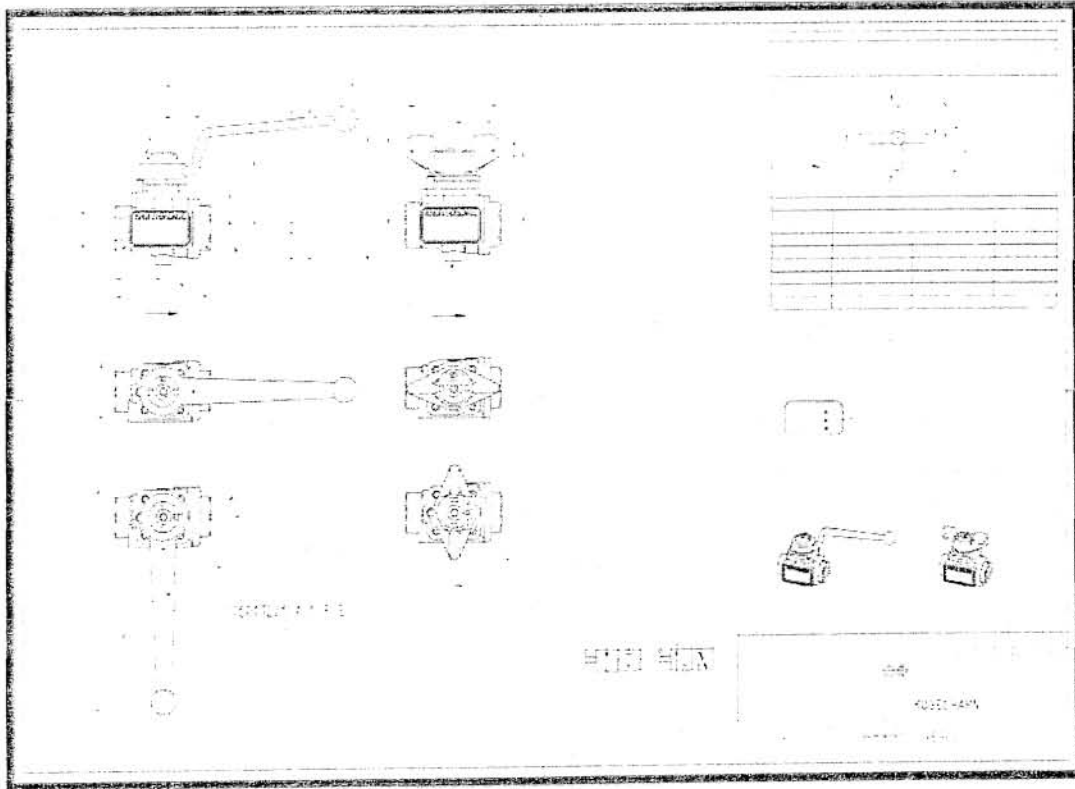

D48 G3/4 to G1/4 adapter

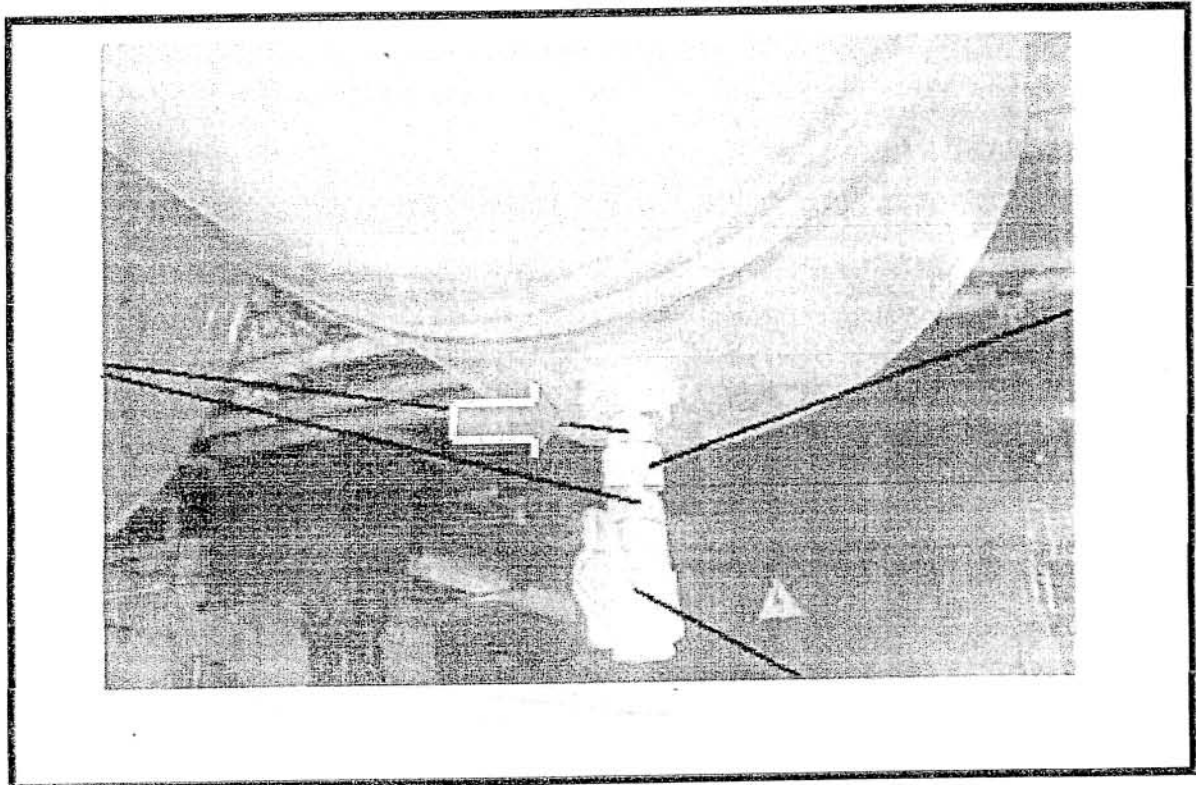

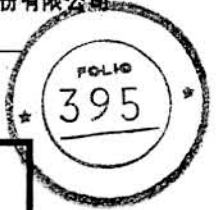

D49 Rotary connector

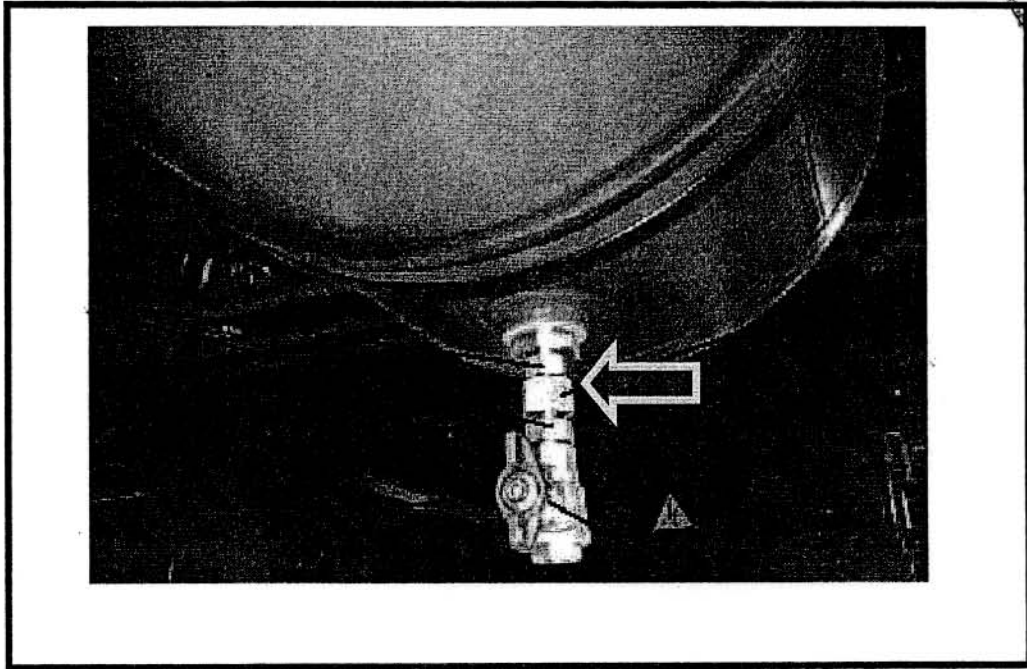

D50 Male connector

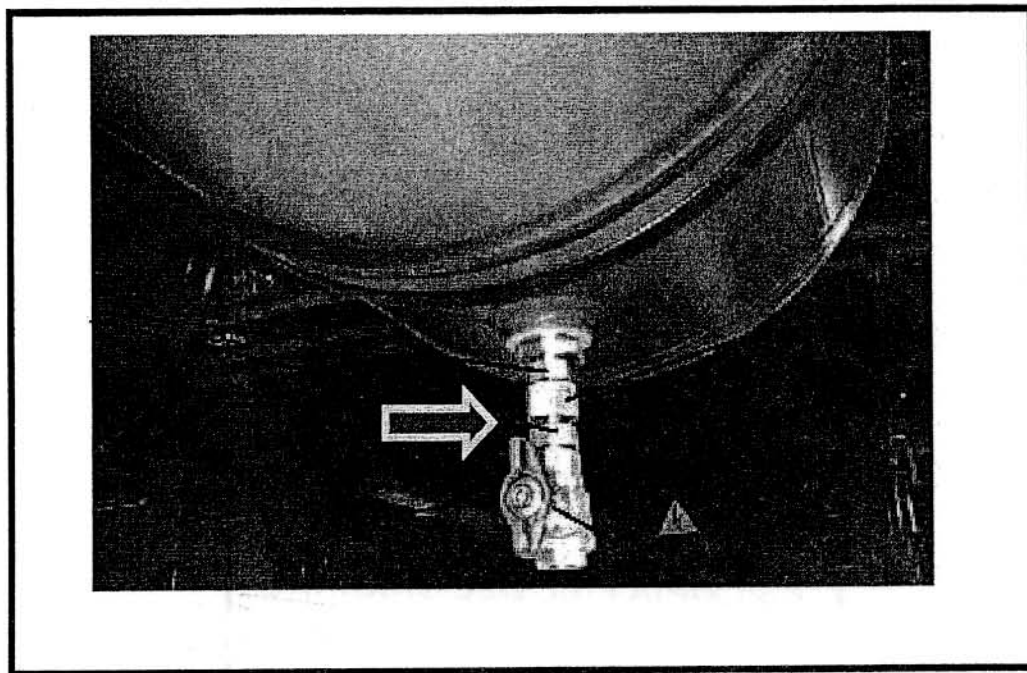

8

A handwritten signature in the bottom right corner of the page.

D53 Silencer

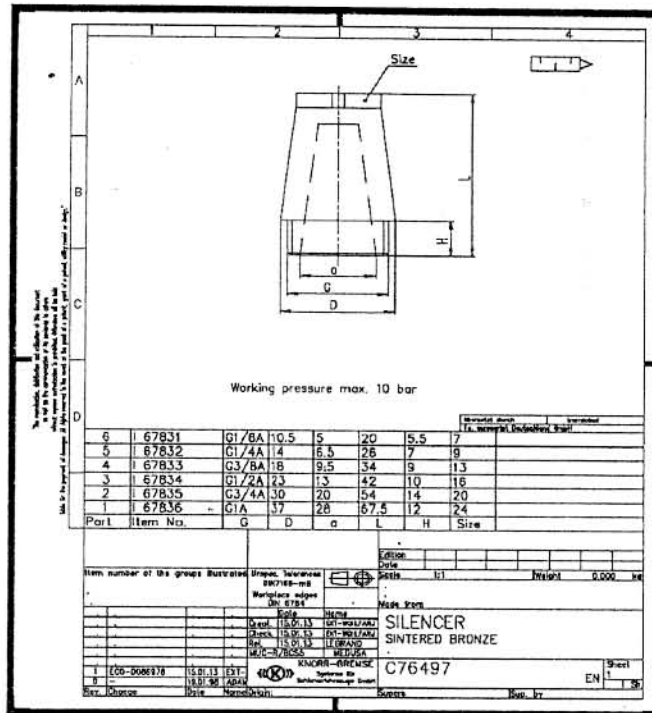

D54 Seal Ring

In Gauge & Duplex gauge

D55 Brake control unit

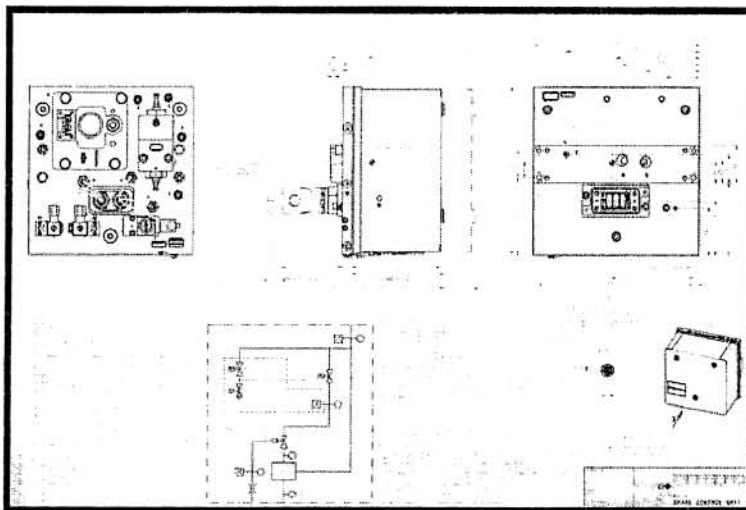

Handwritten mark resembling a stylized 'Z' or '8'.

Handwritten signature.

D56 Hose pipes for parking brake

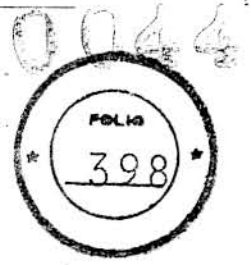
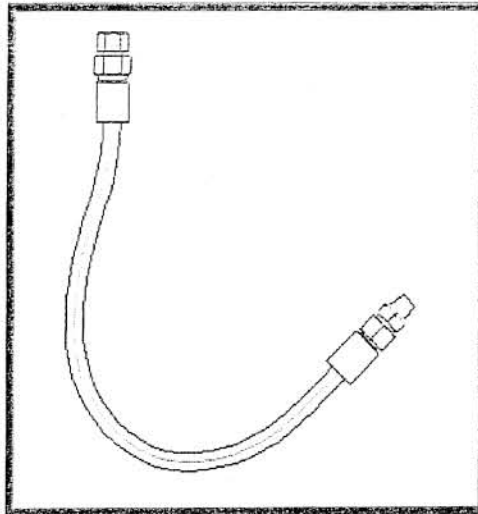

Part E HVAC System

E1 Complete HVAC System (King Guangzhou)

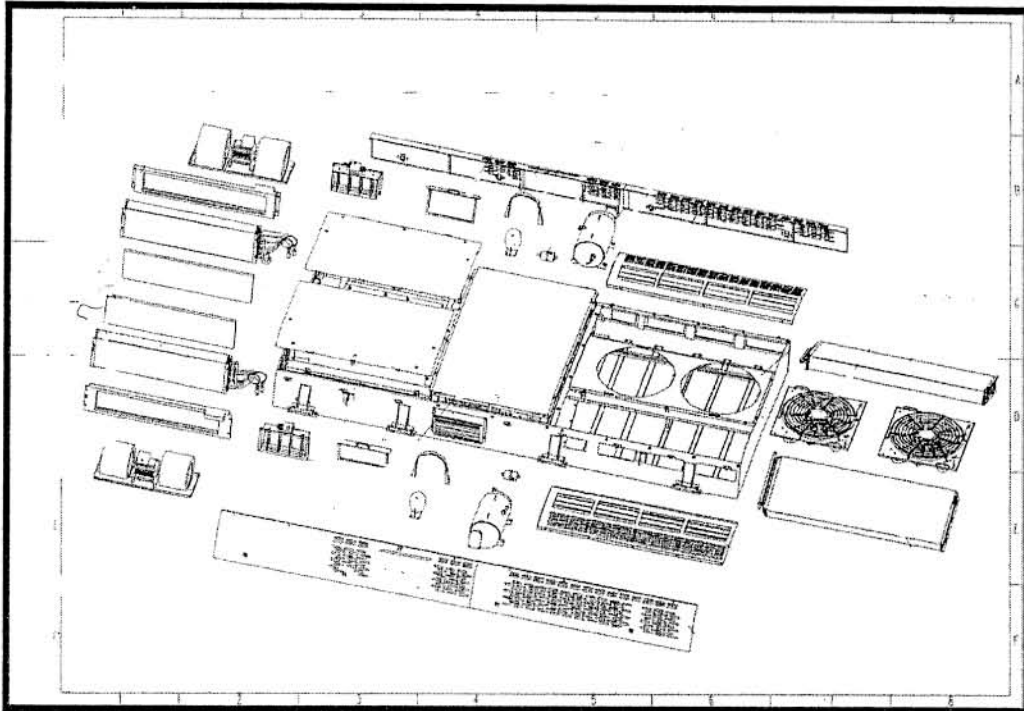

E2 Compressor

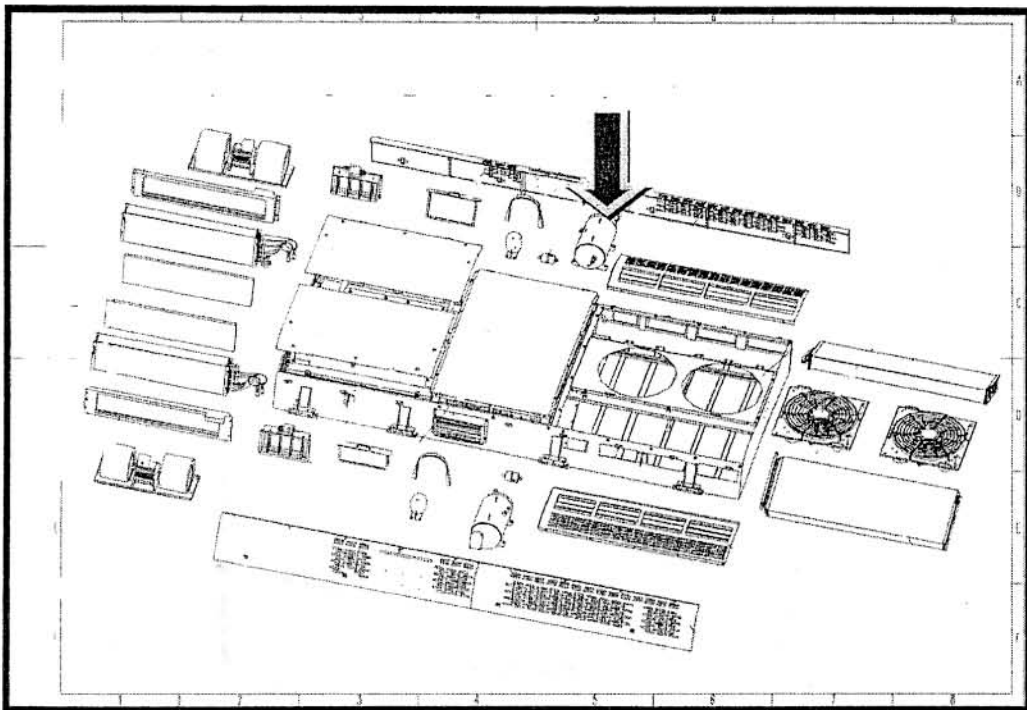

[Handwritten mark]

[Handwritten signature]

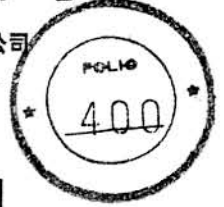

E3 Condenser fan motor

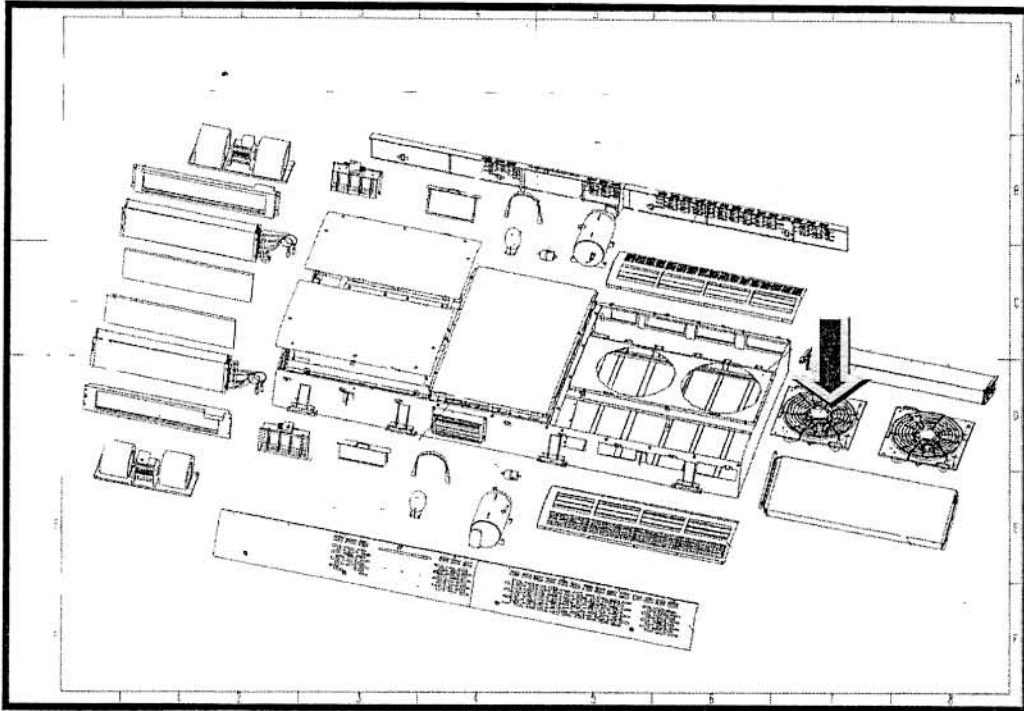

E4 Evaporator fan motor

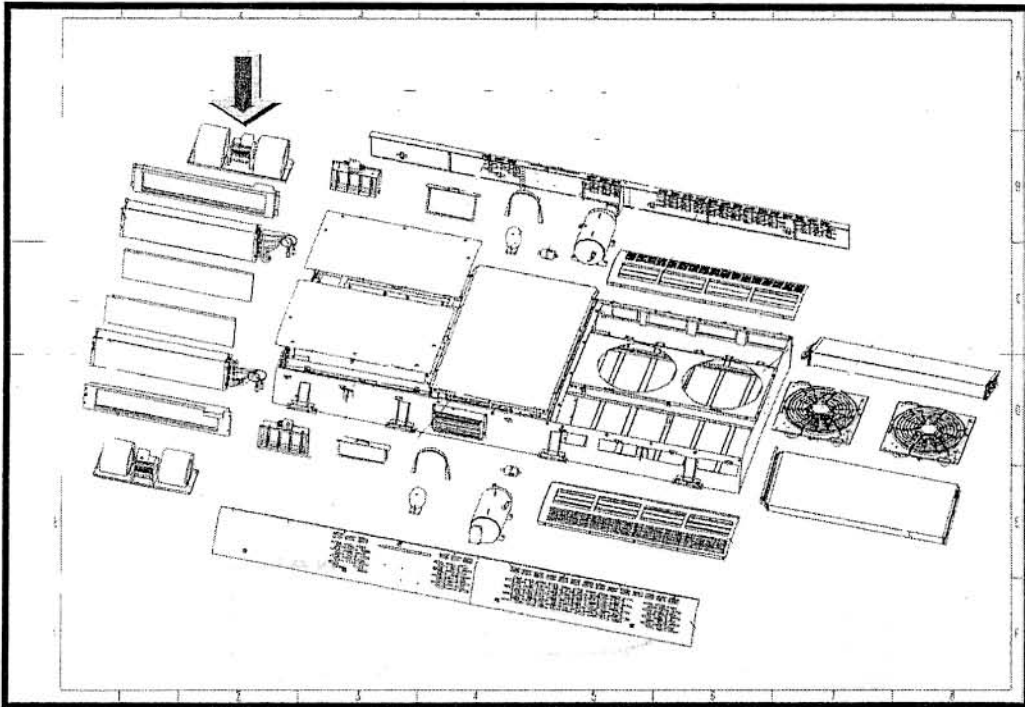

[Handwritten mark]

[Handwritten signature]