

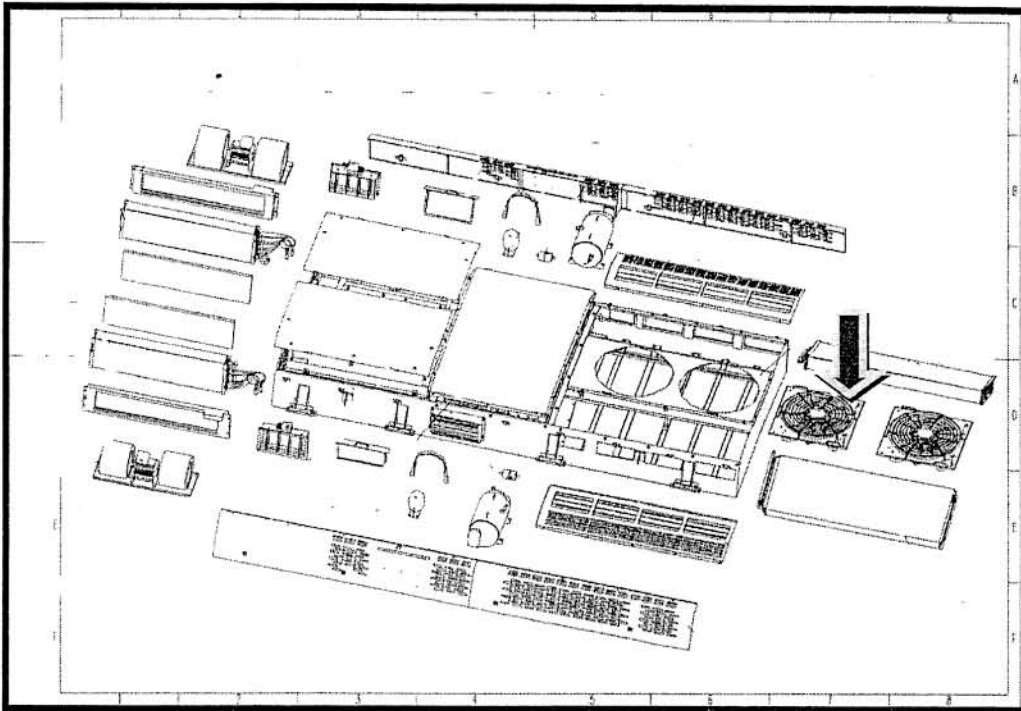

E5 Condensate fan

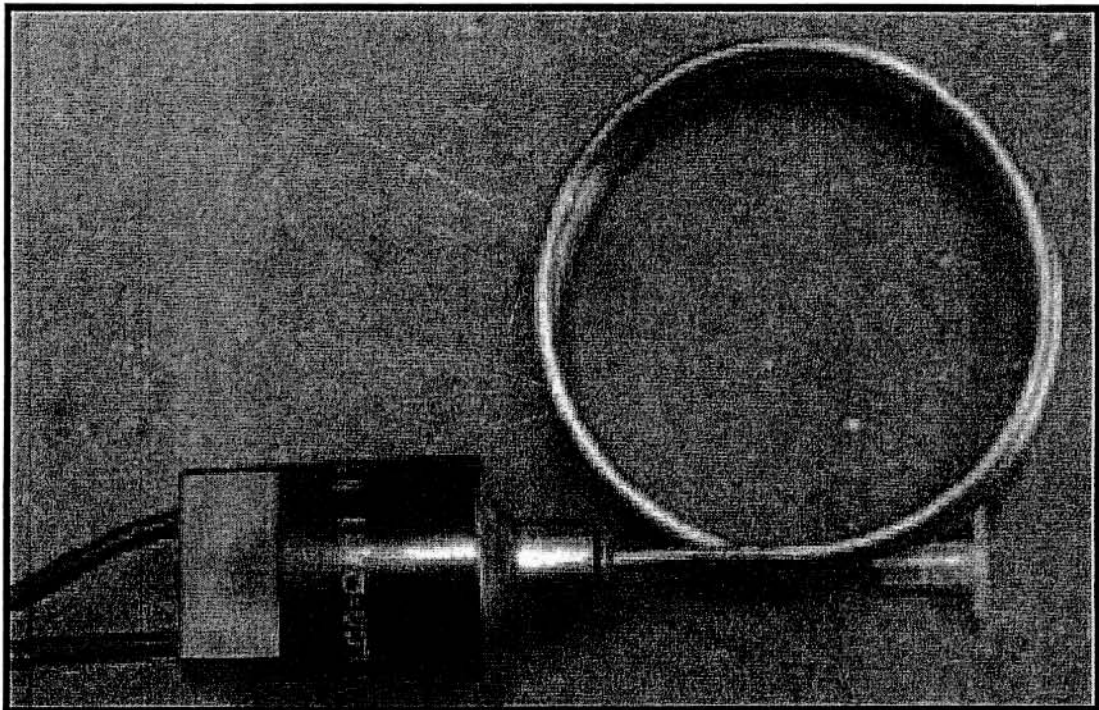

E6 Dual pressure control



8

A handwritten signature in black ink, located in the bottom right corner of the page.



E7 High pressure control

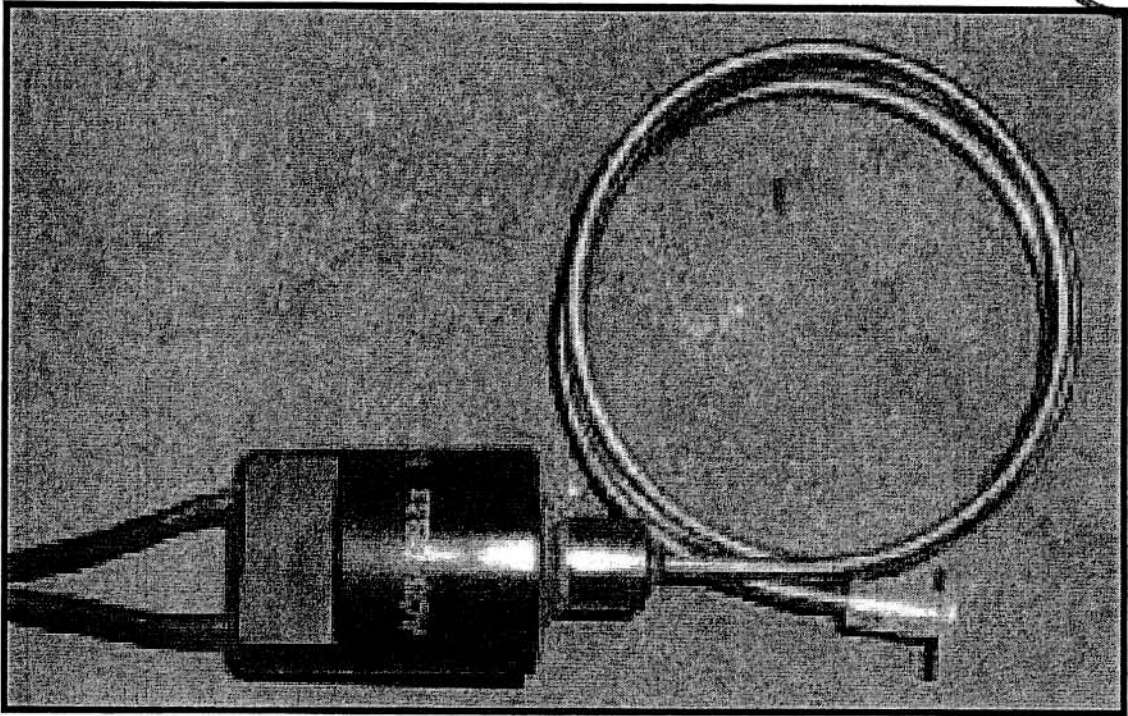

E8 Filter drier

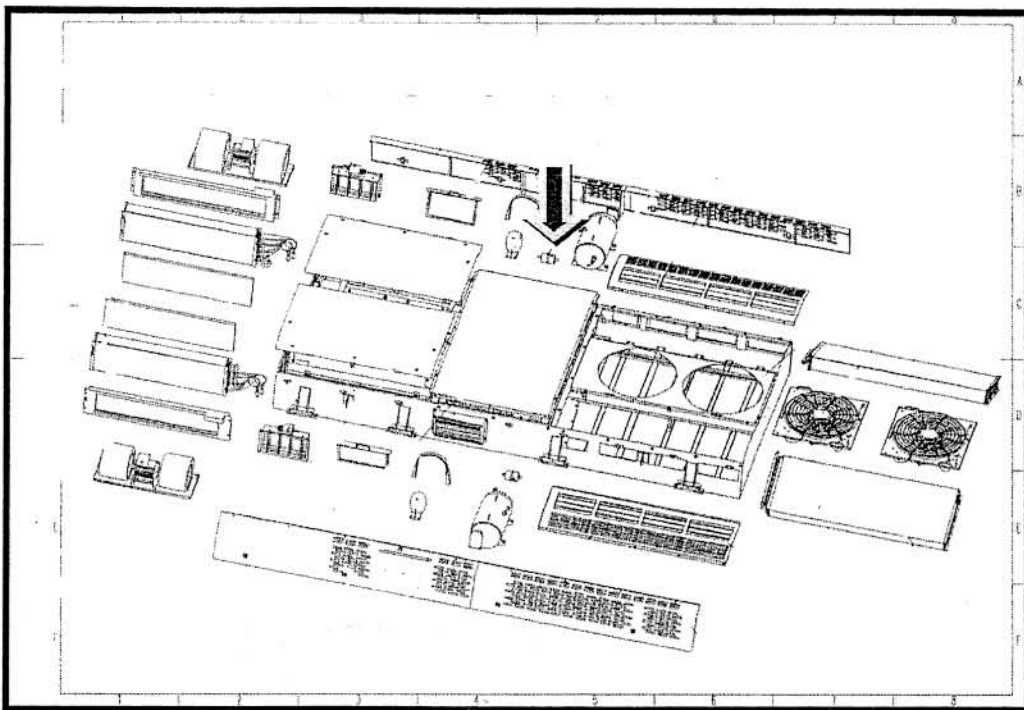

E9 Refrigerant R407C

A handwritten signature in the bottom right corner of the page.

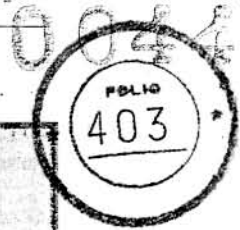

E10 Supply air seal

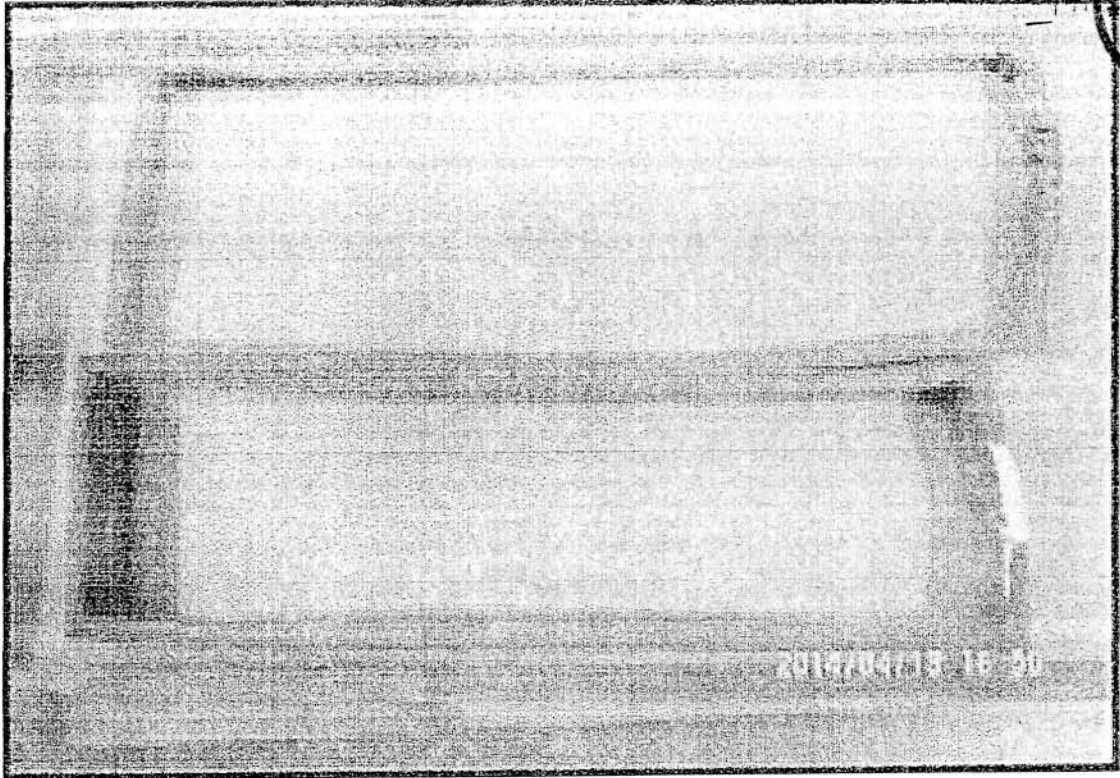

E11 Return air seal

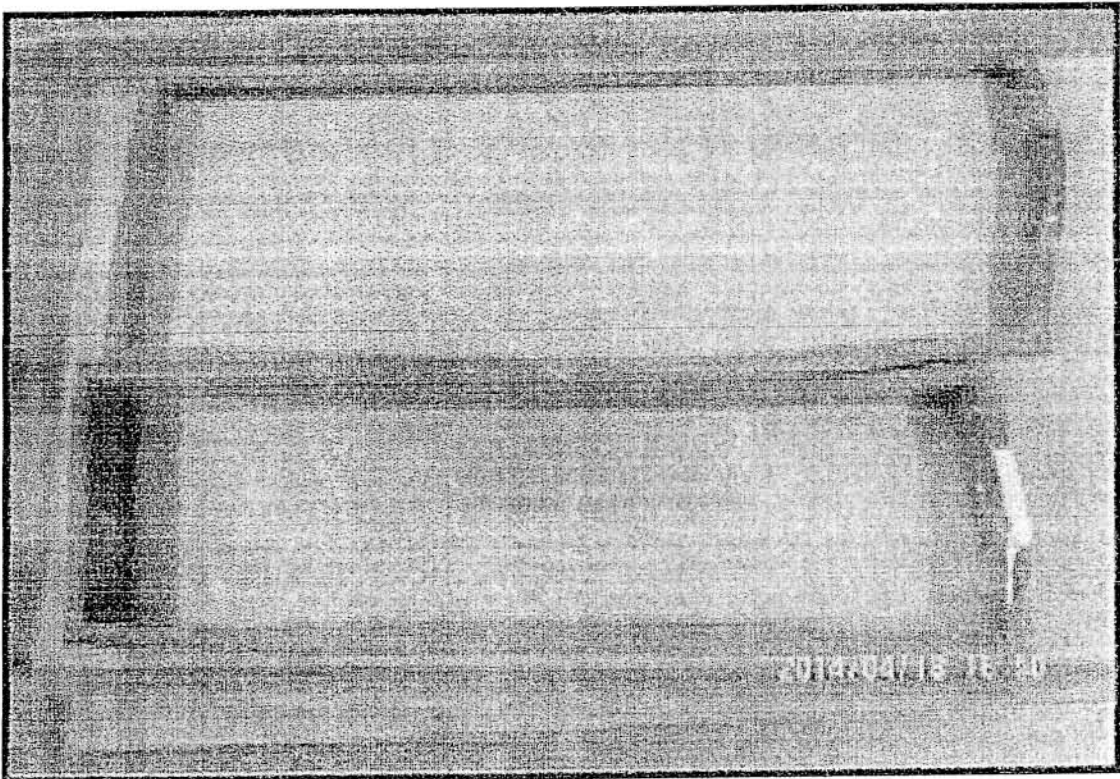



E12 Supply air fan

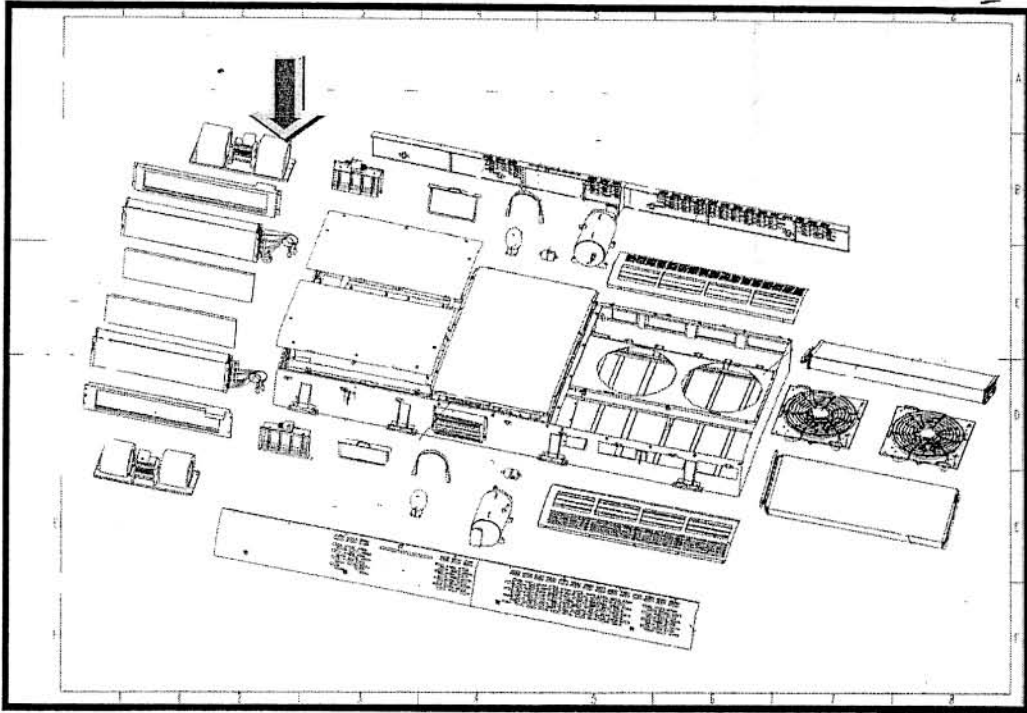

E13 3 stage transformer (250w)

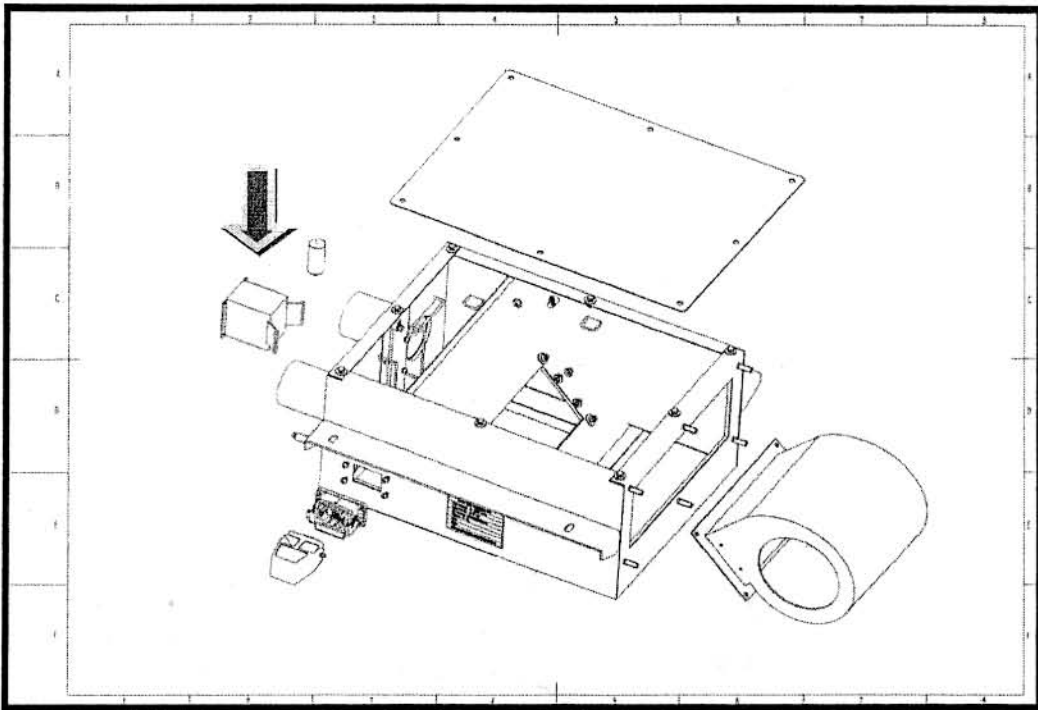

J

[Signature]

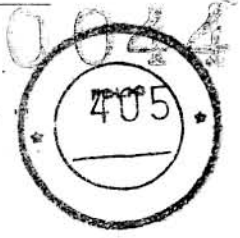

- E14 Ventilating circuit breaker
- E15 Circuit breaker 2
- E16 Circuit breaker 3
- E17 Circuit breaker 4
- E18 Contactor 1
- E19 Contactor 2
- E20 Contactor 3
- E21 Relay
- E22 Power failure relay
- E23 Microprocessor
- E24 Rotary switch

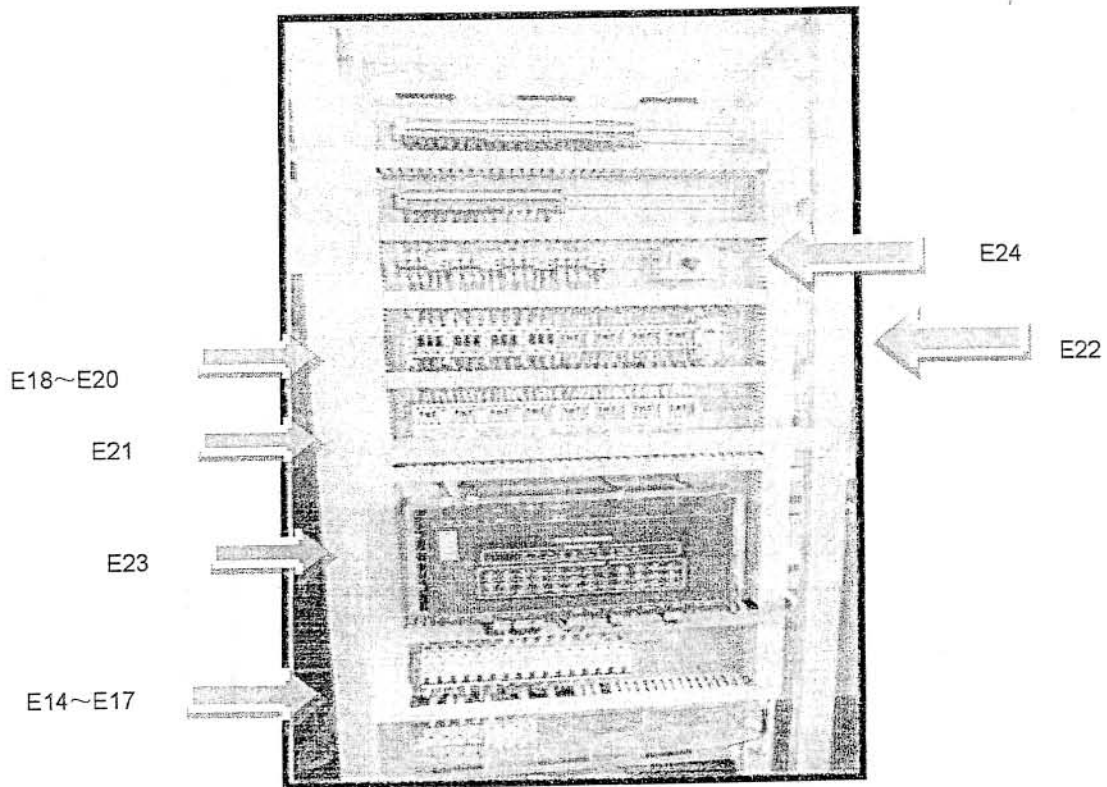

E25 Damper

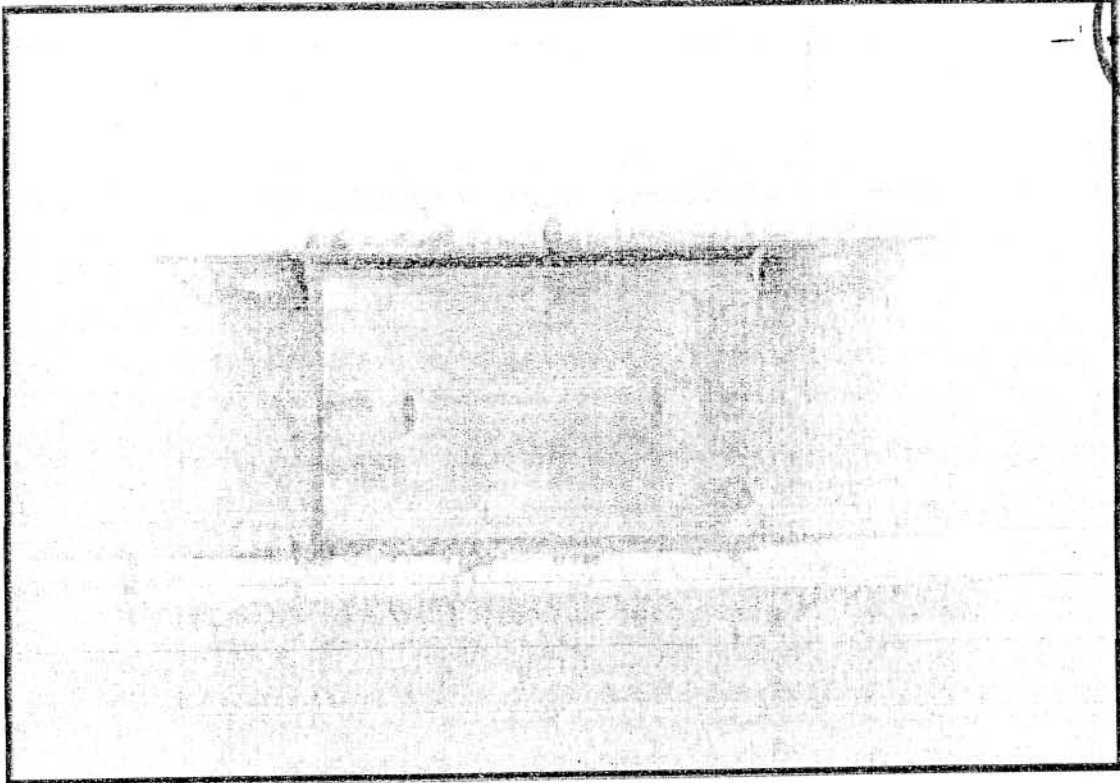
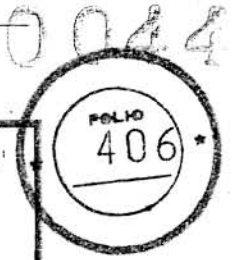

E26 Suction filter

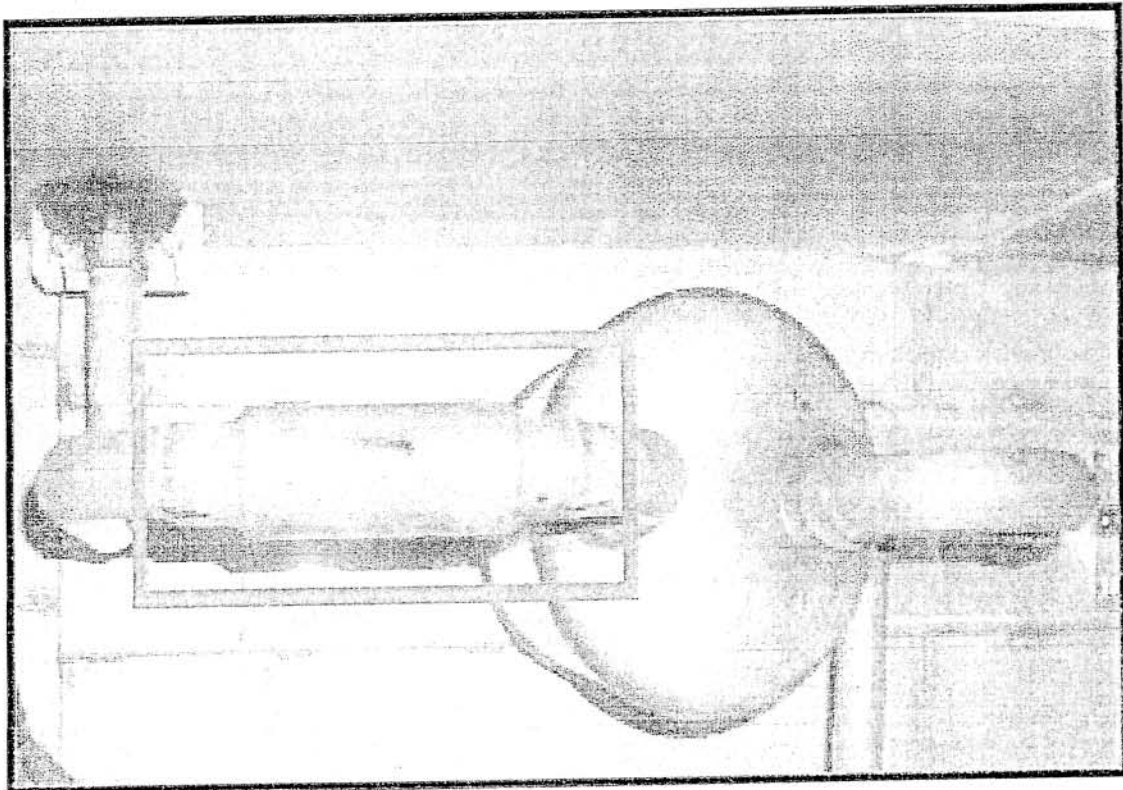



E27 Gas and liquid separator

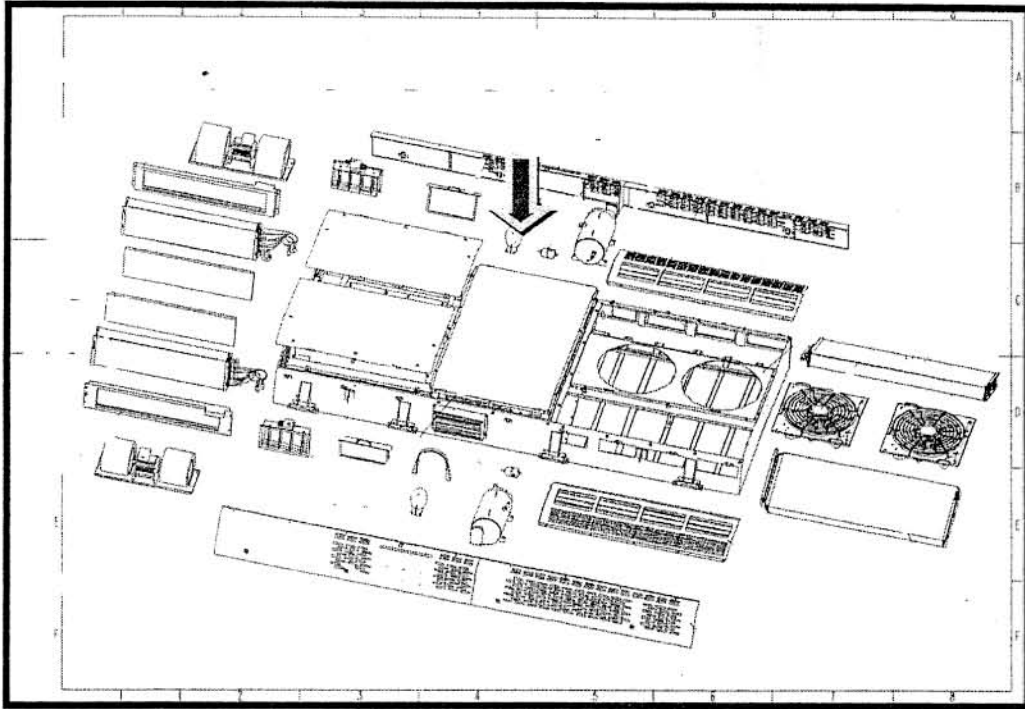

E28 Electric heater one

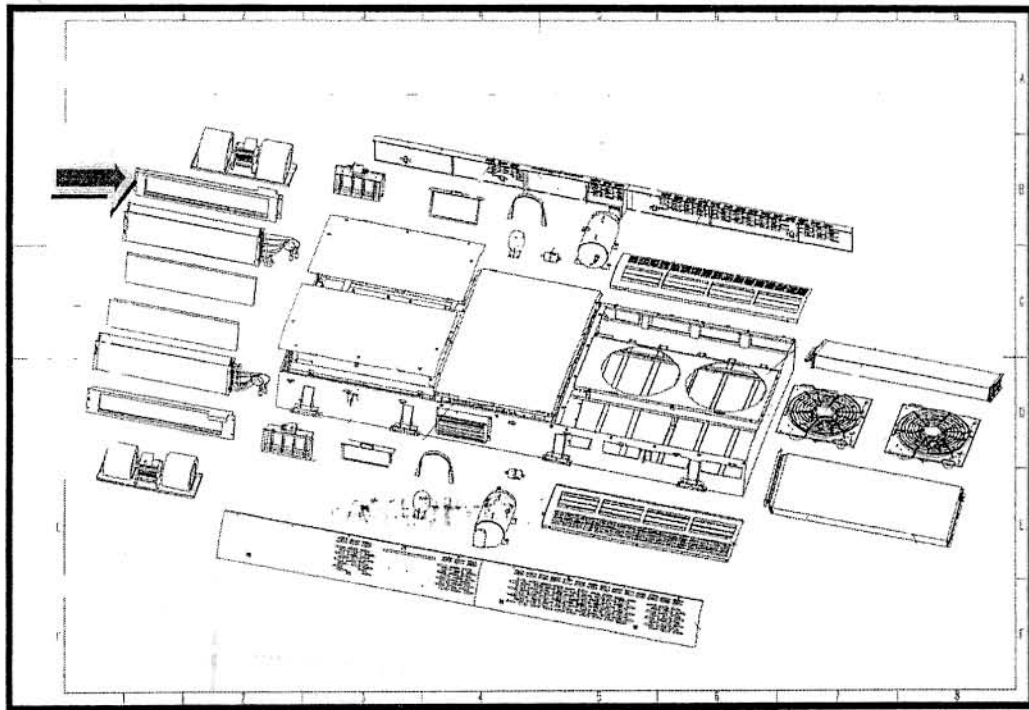

8

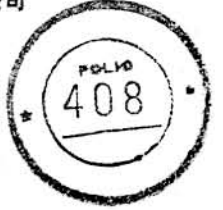

E29 Electric heater two

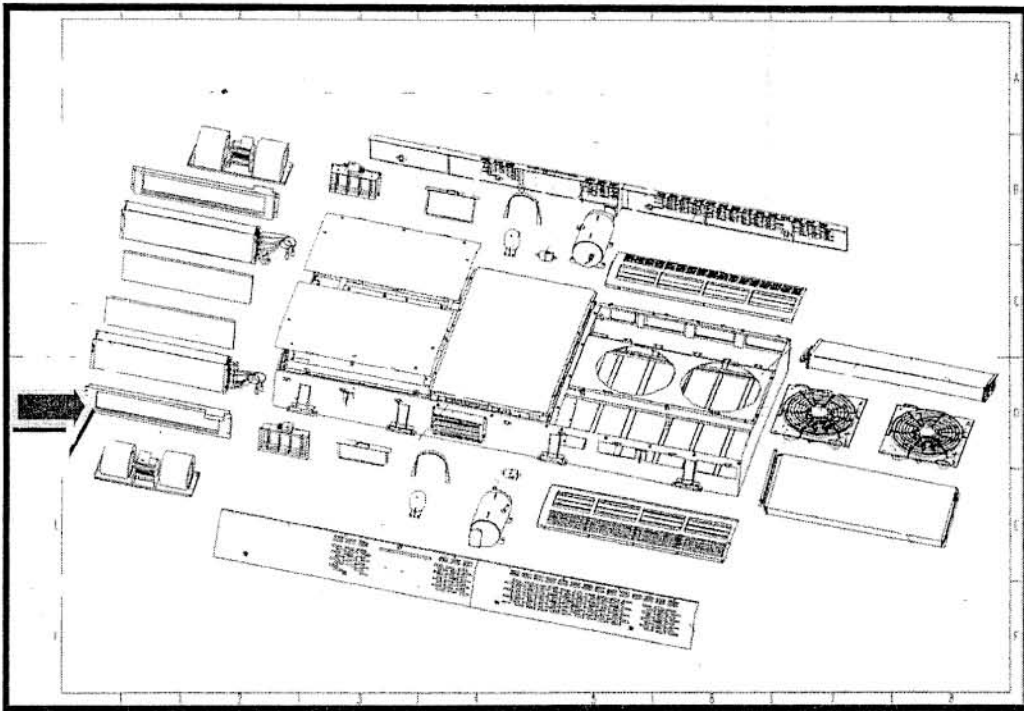

E30 Fresh air damper

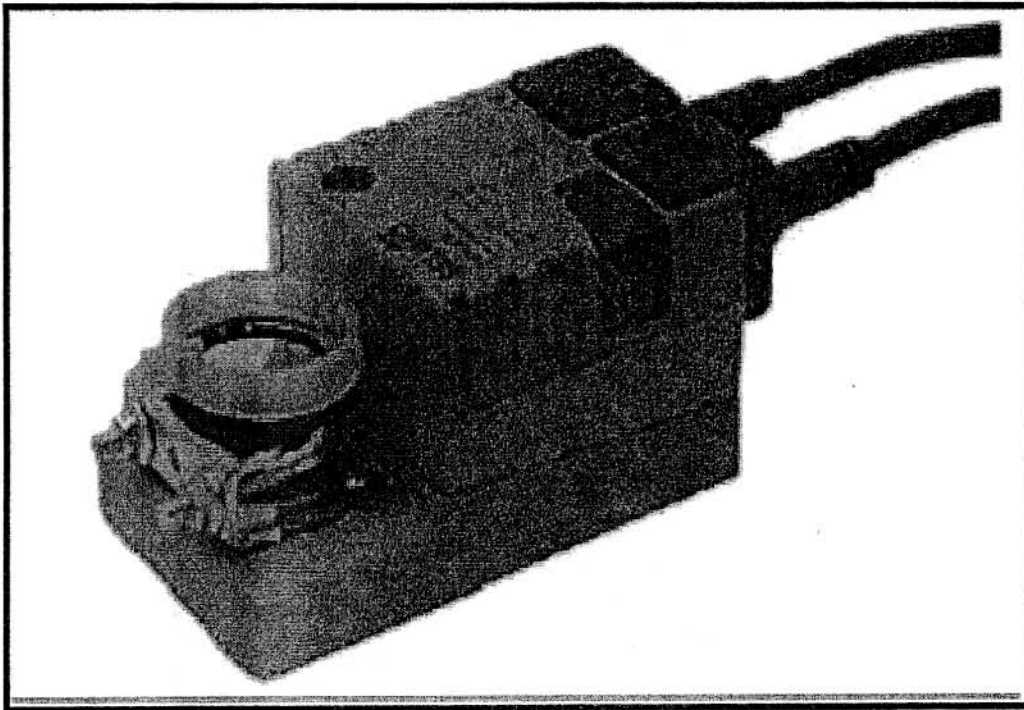

J

Car



E31 Temperature sensor

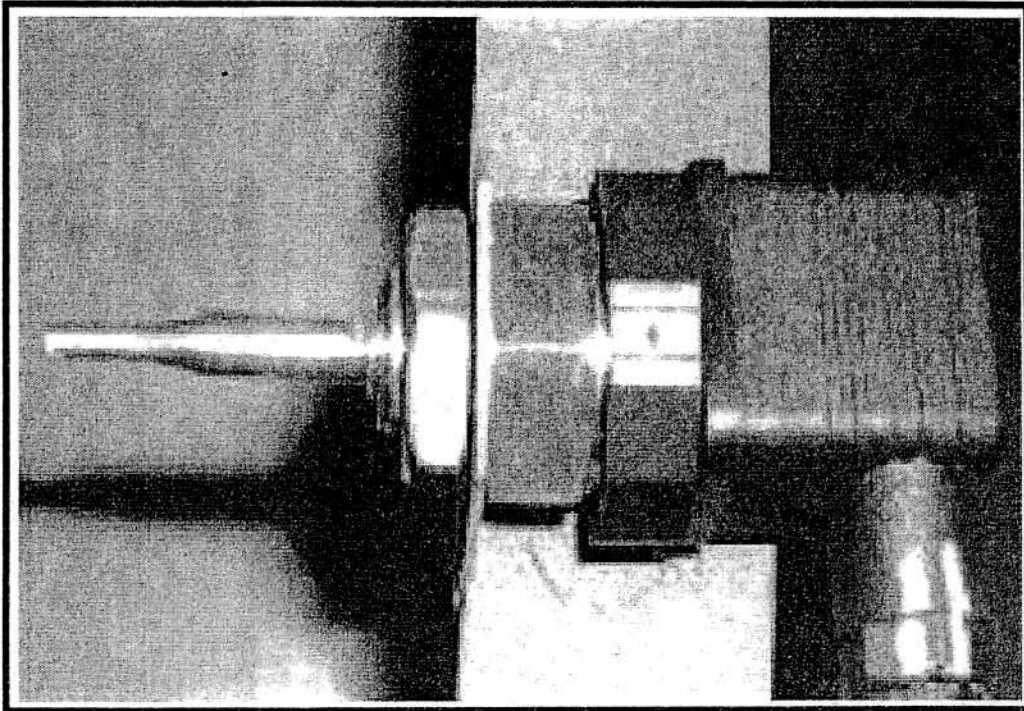

E32 Main circuit connector

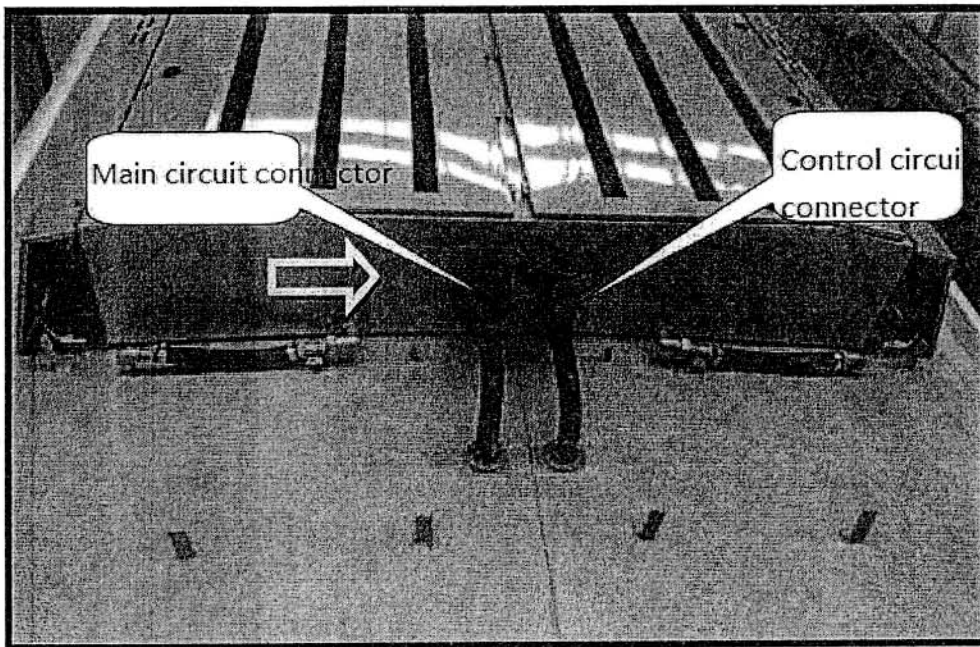

2

Com



E33 Control circuit connector

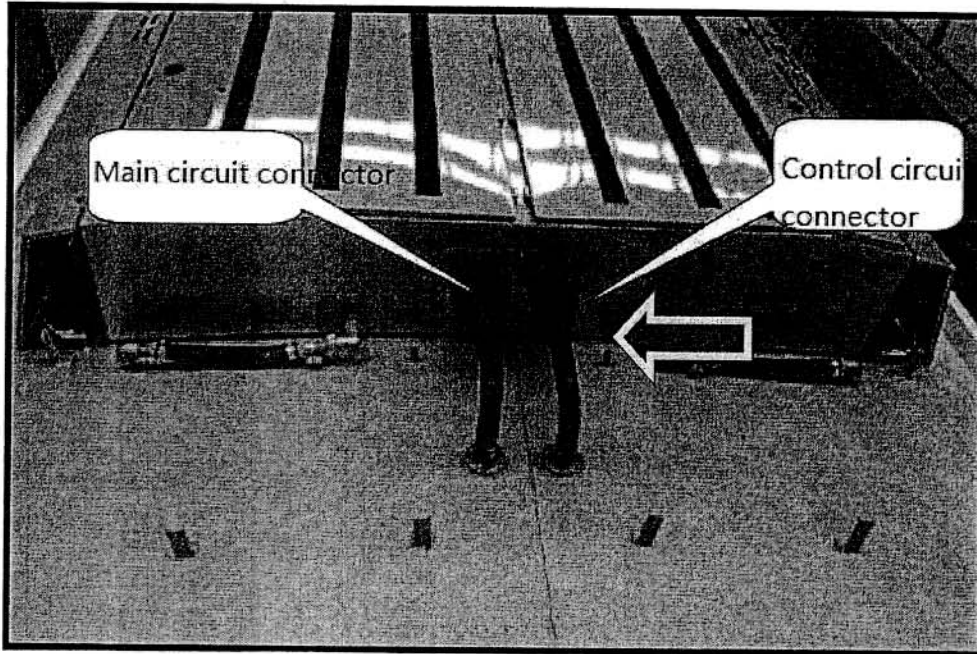

E34 Supply air fan (cab)

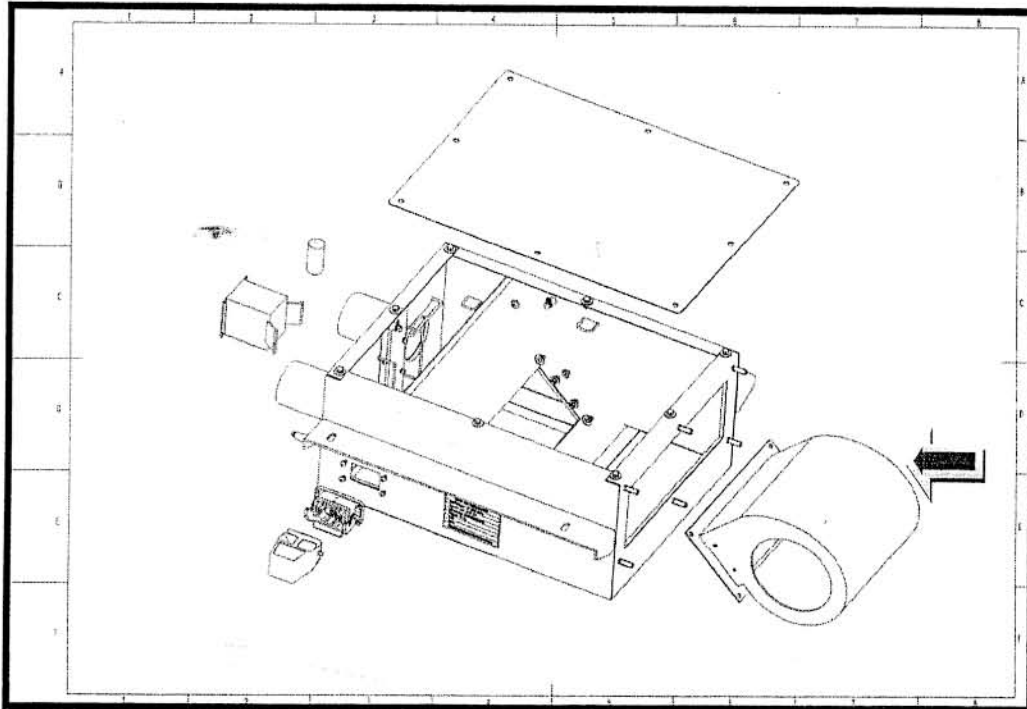

2

Signature

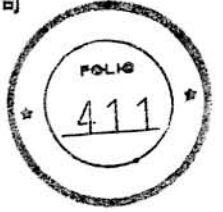

E35 Connector

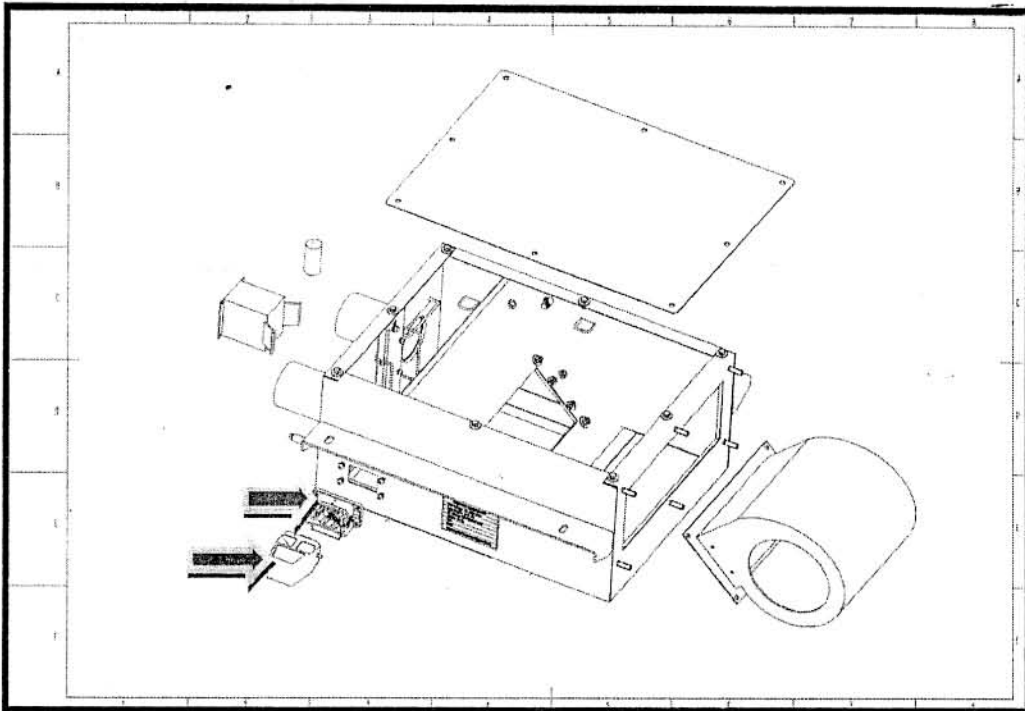

E36 Thermal relay

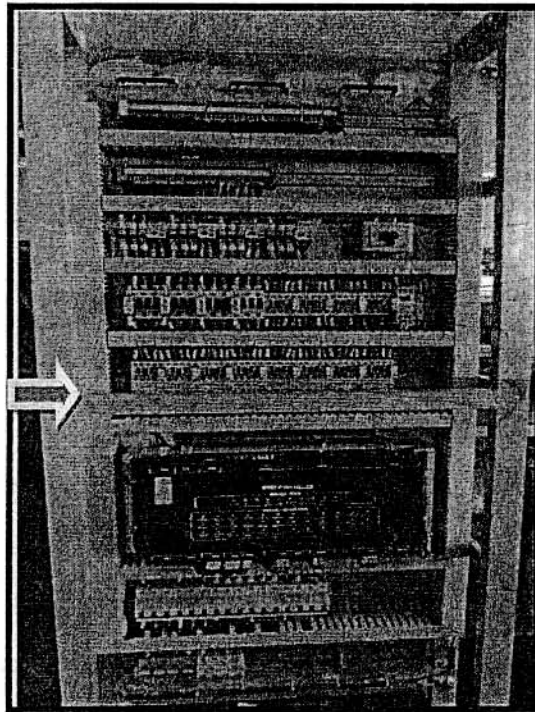

J

Com



E37 Thermal overload relay 2

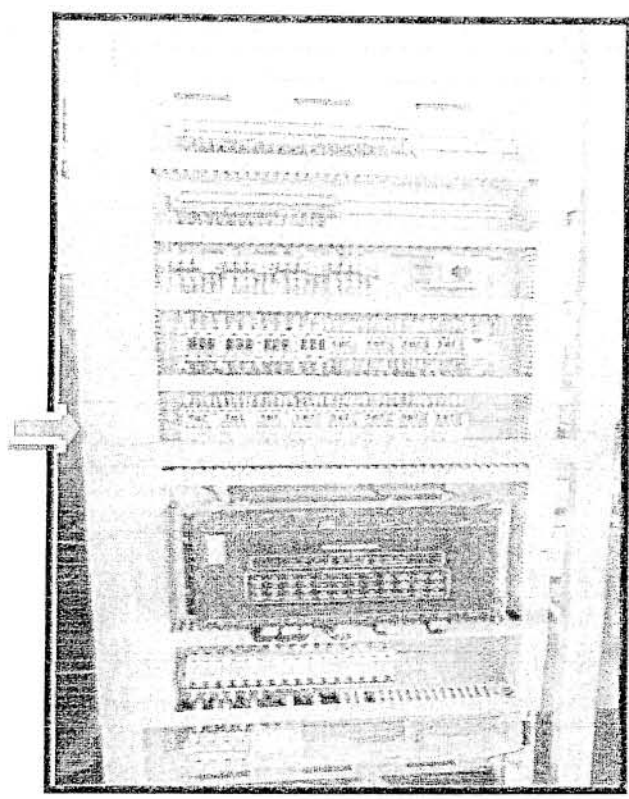
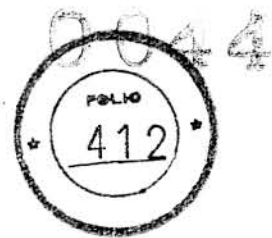

E38 Thermal overload relay 3

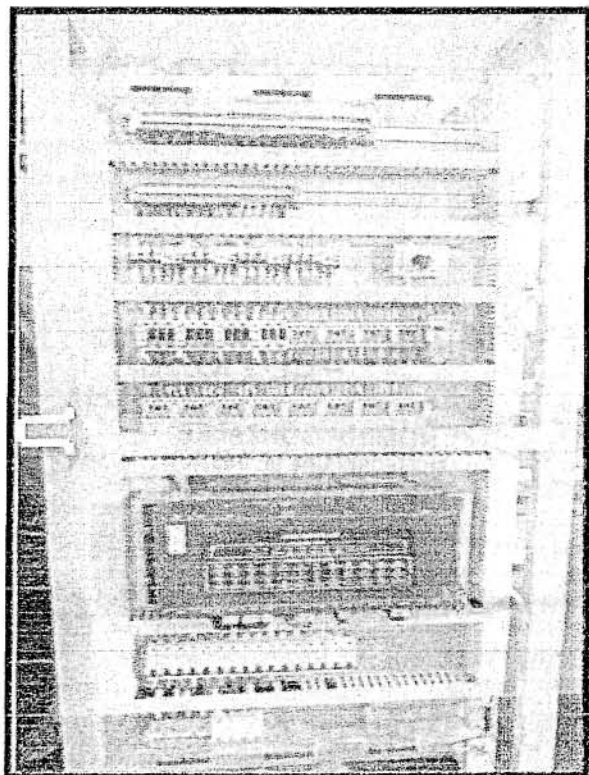

Part F Bogie

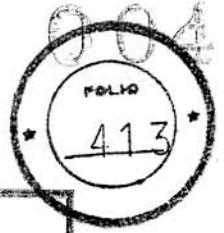

F1 Wheelset assembly

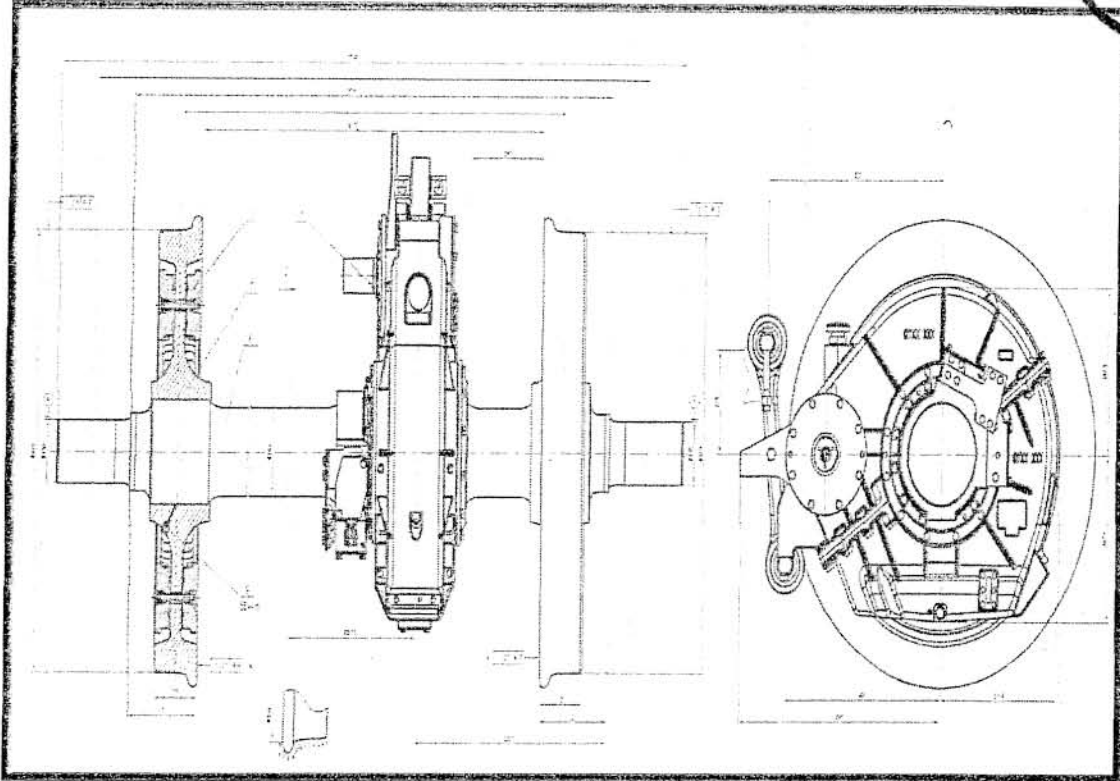

F2 Wheelset assembly

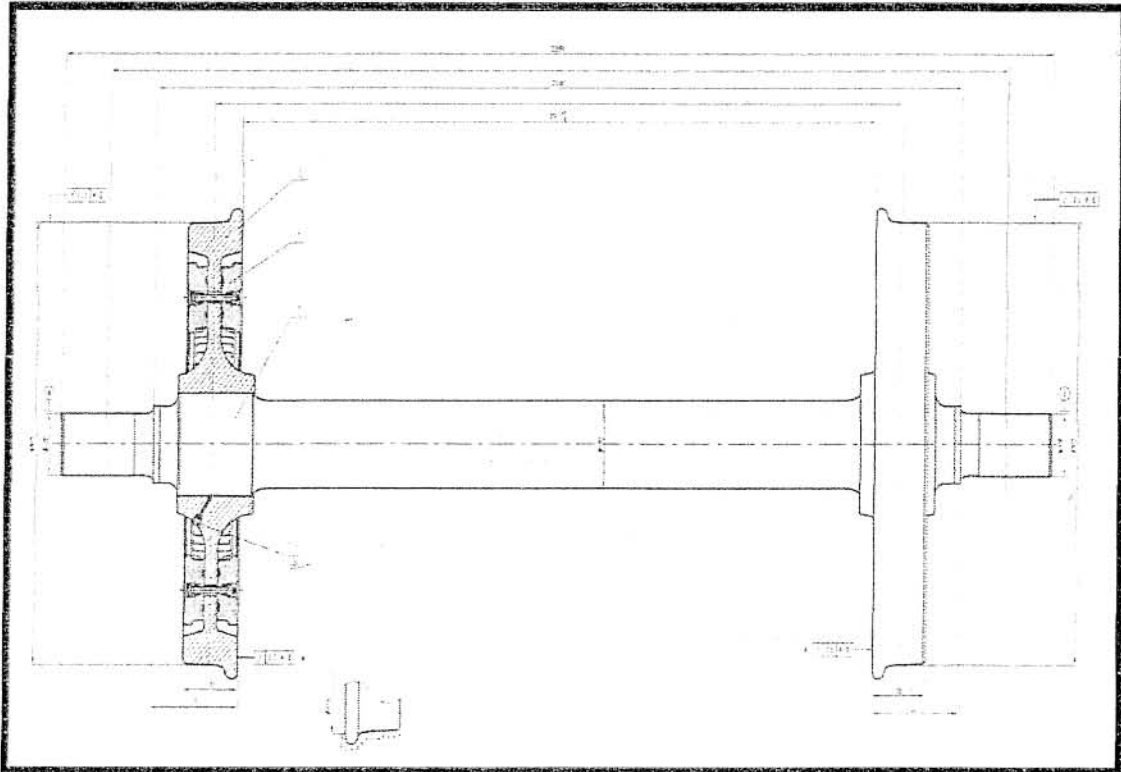

F3 Leveling valve adjusting lever

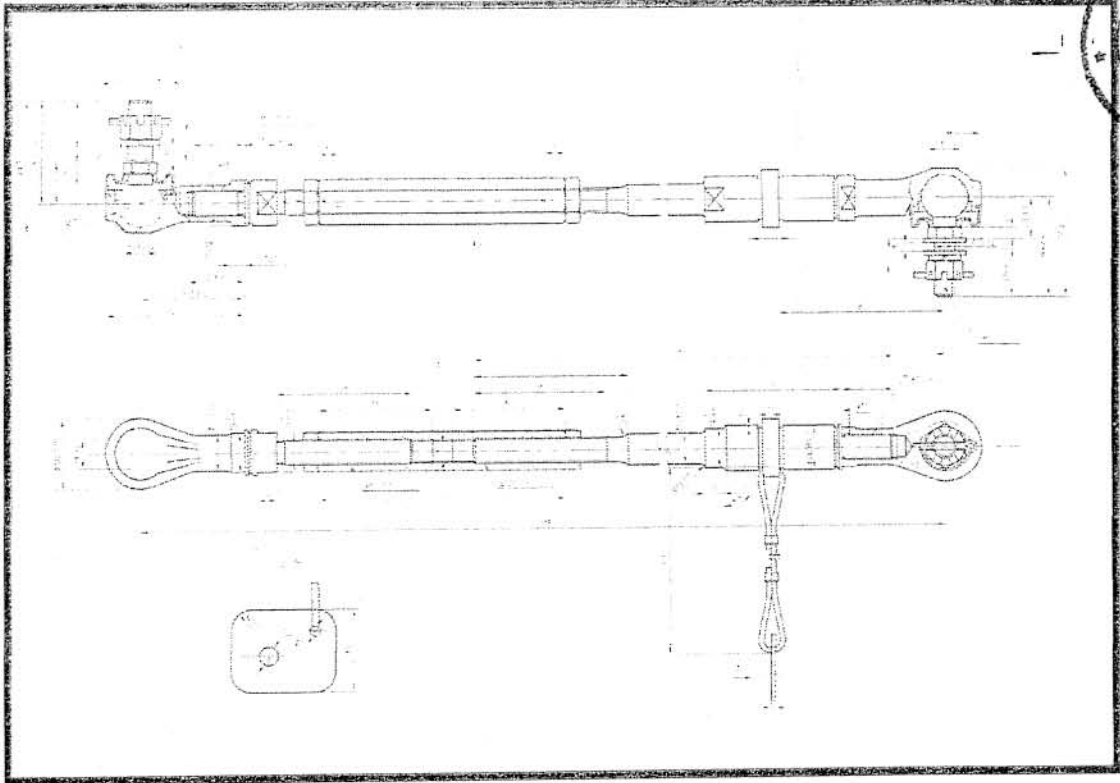

F4 Differential pressure valve left

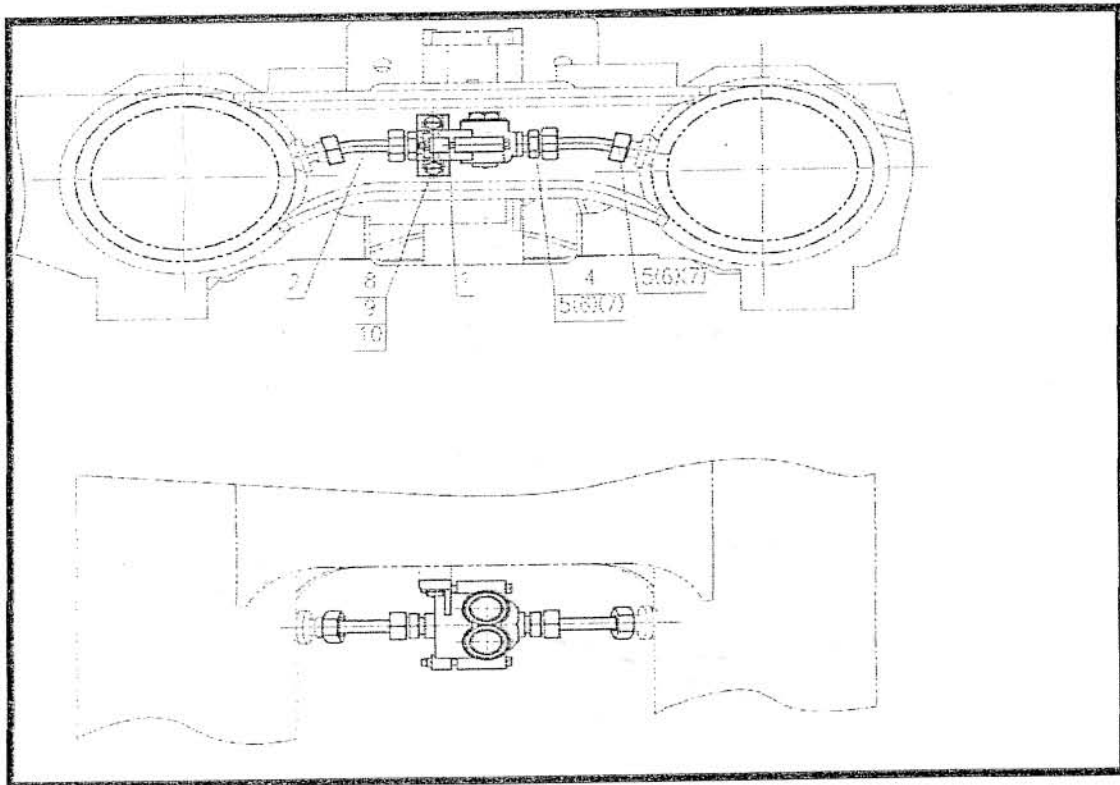

F5 The steel double helical spring

0044
FOLIO
415

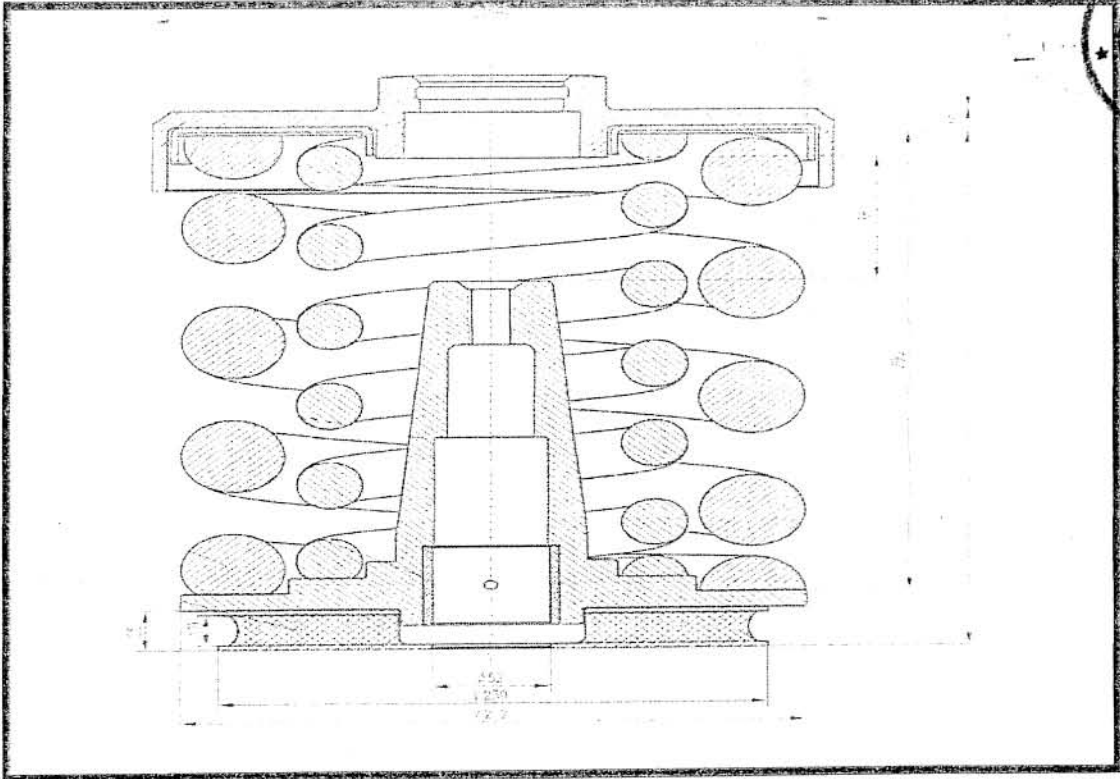

F6 Axle box bearing

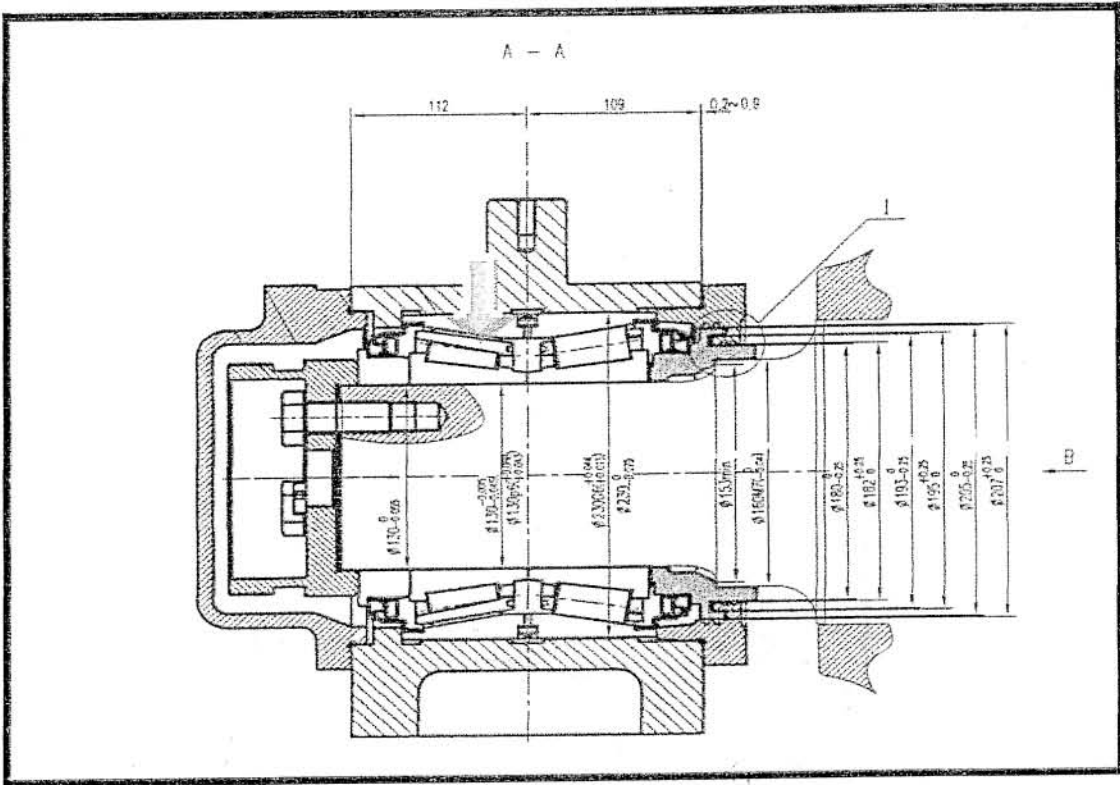

F7 Air spring

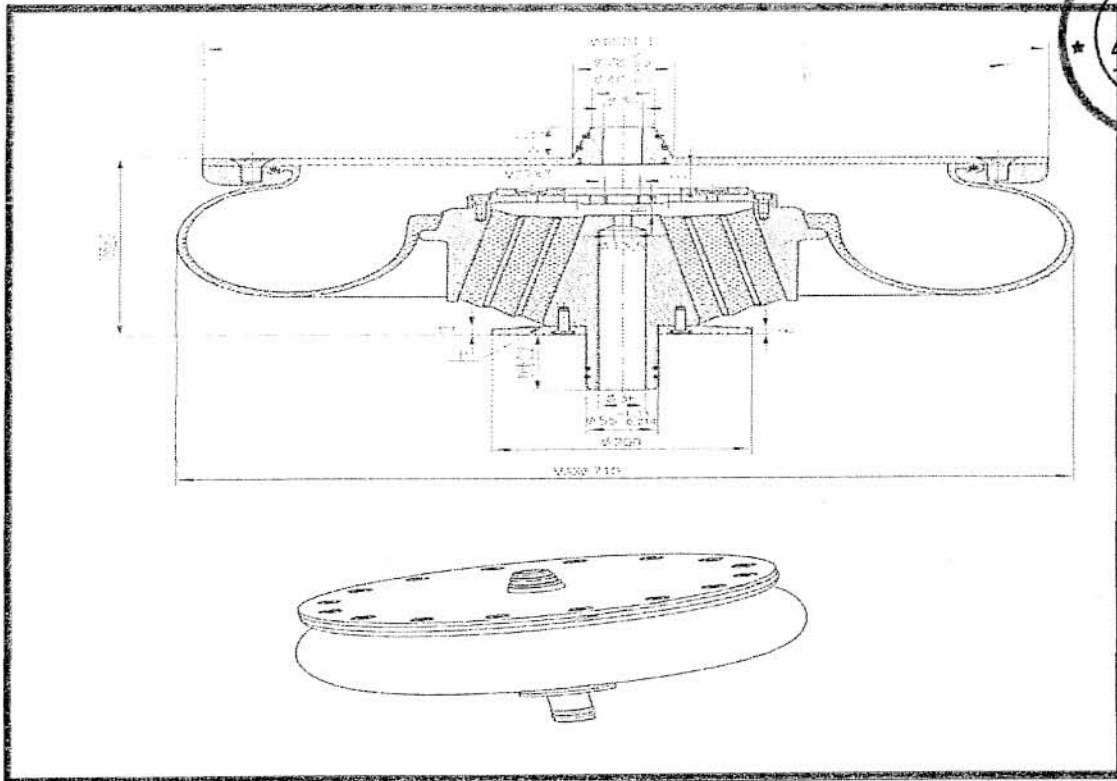

F8 Lateral buffer stop

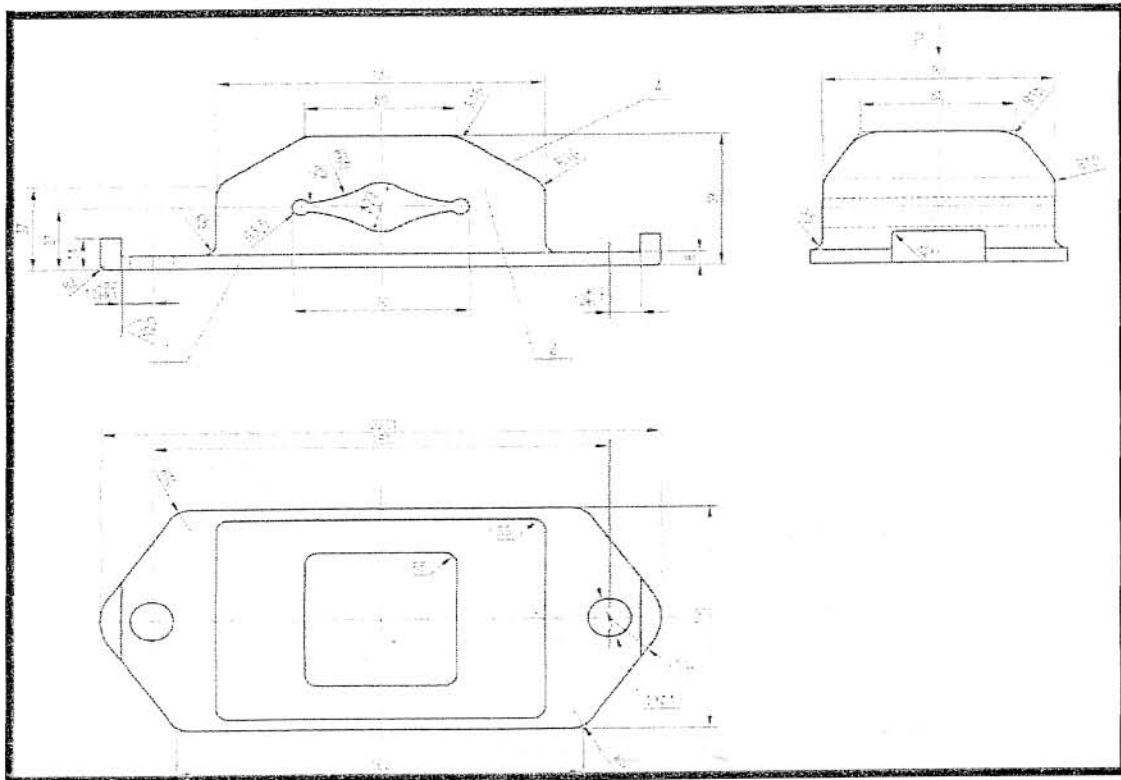

F9 Traction bar assembly

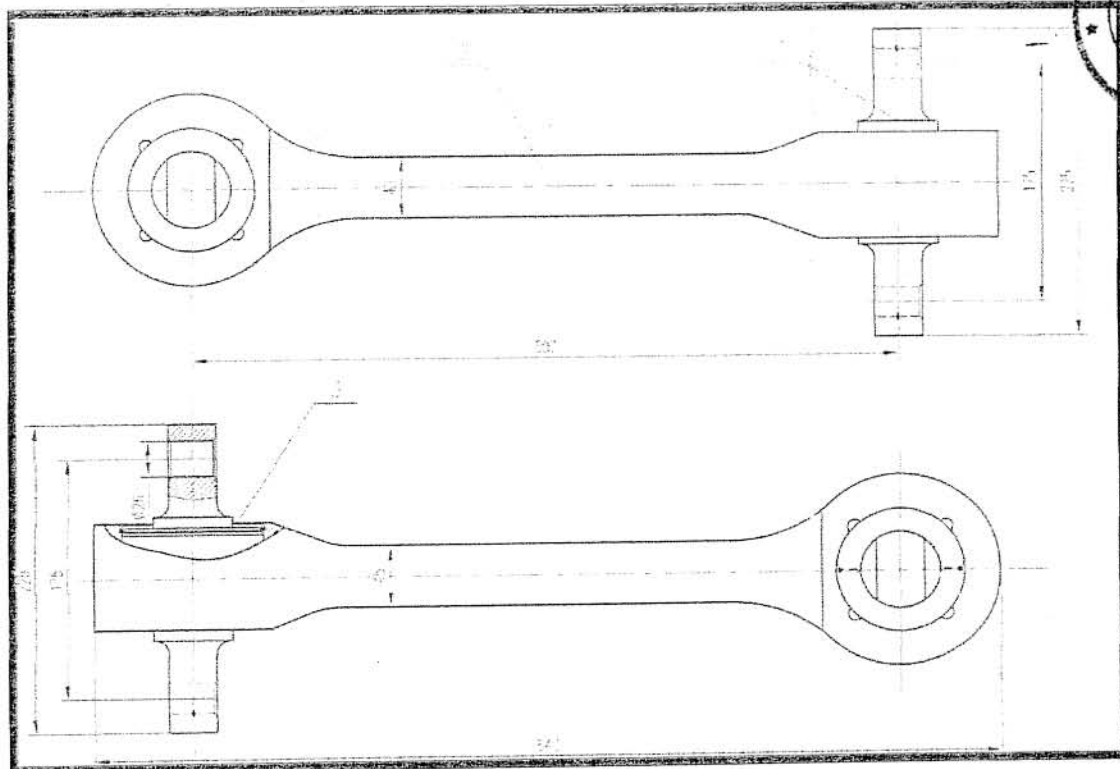

F10 Wheel flange lubricating device (right)

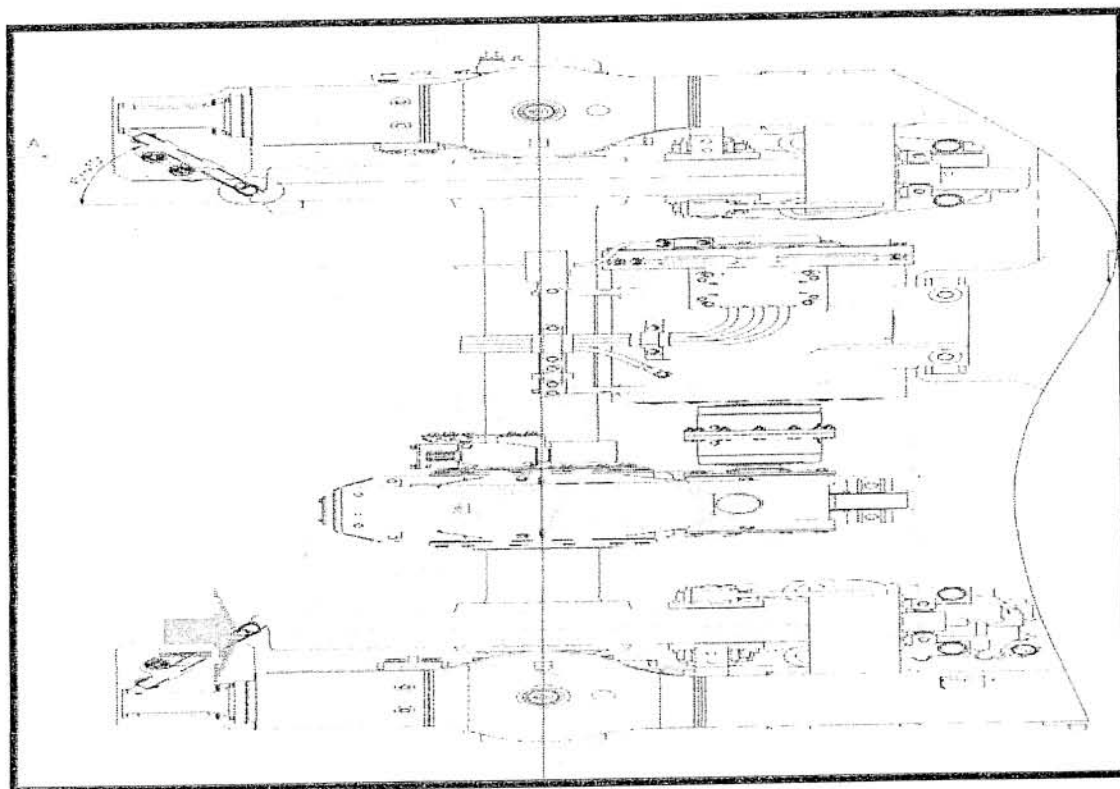

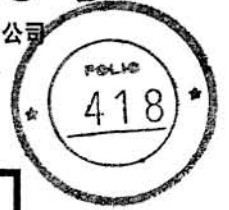

F11 Wheel flange lubricating device (left)

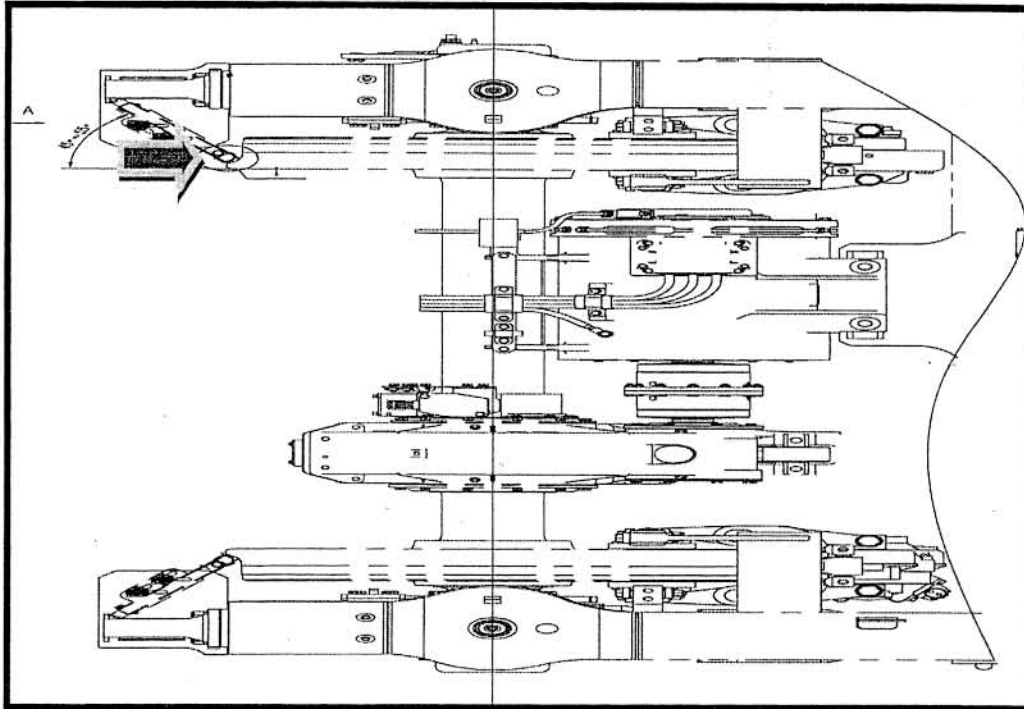

F12 Lateral oil damper

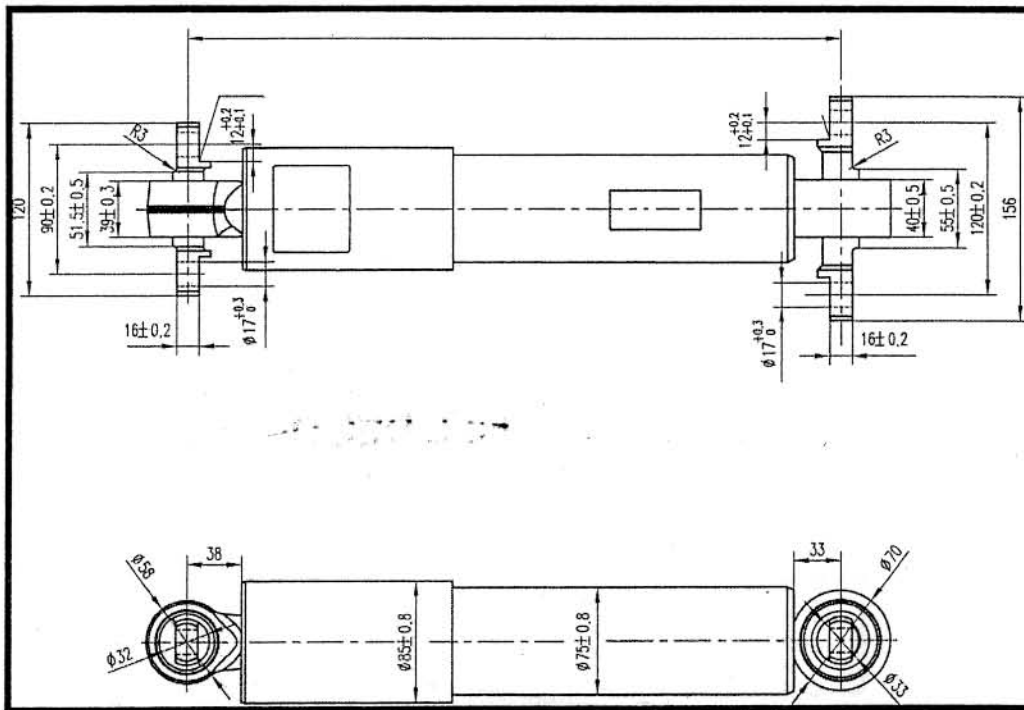

Car

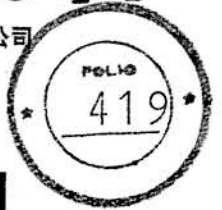

F13 Primary vertical damper

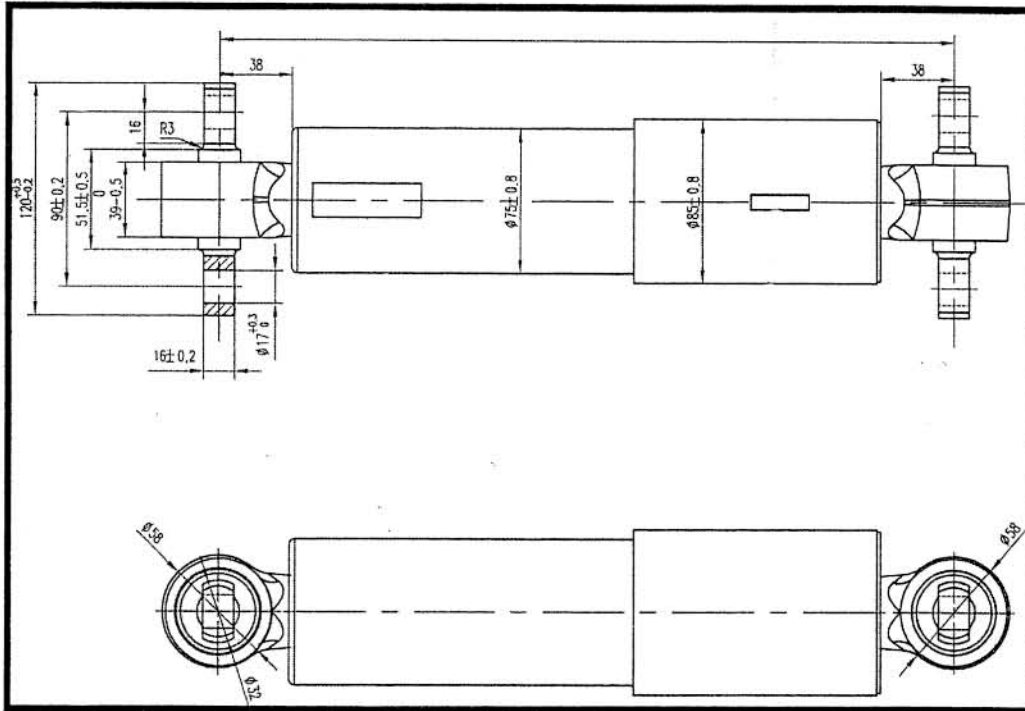

F14 Tee Pipe Joint

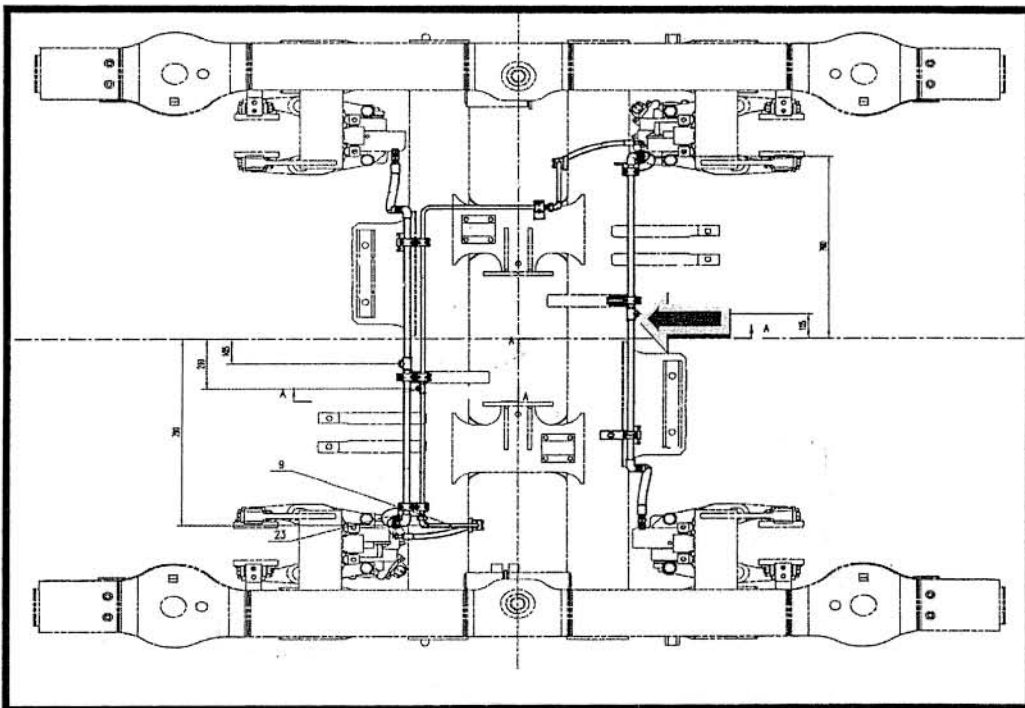

J

[Handwritten signature]



0044

F15 Elbow Joint

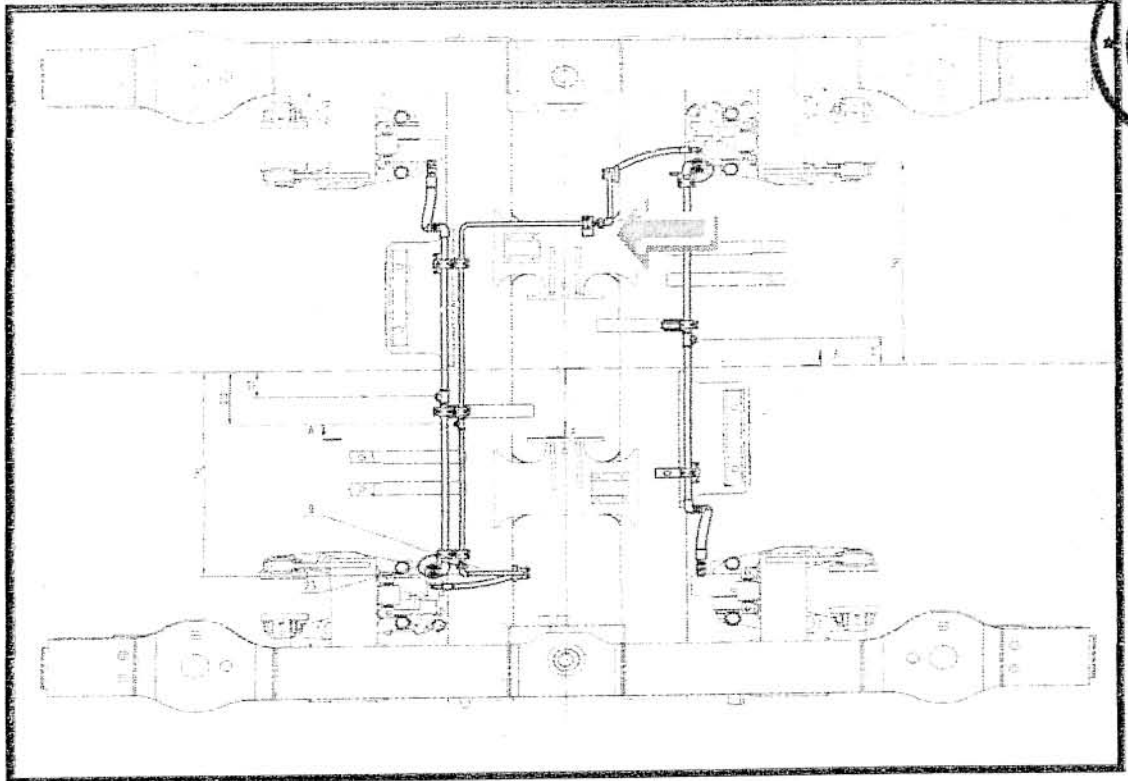
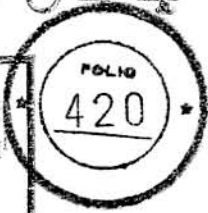

F16 Front cover at axle end

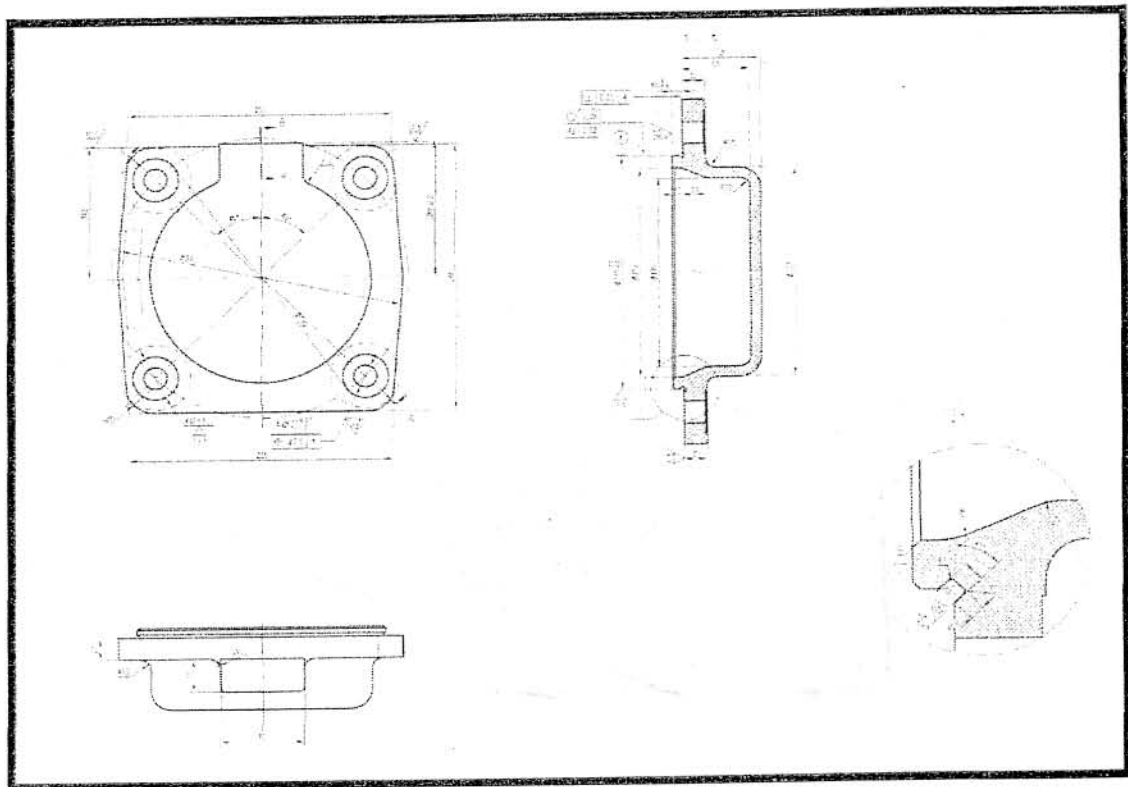

F17 End cover assembly of grounding sensor

0044
FOLIO
421

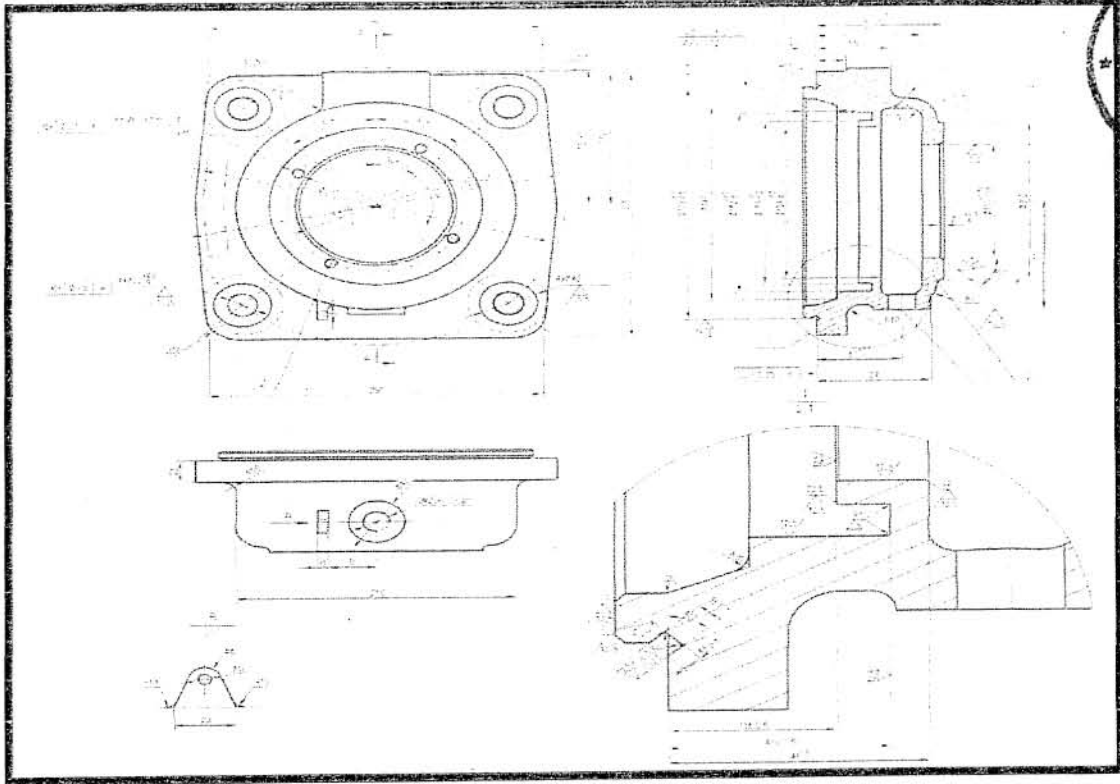

F18 Grounding axle end cover

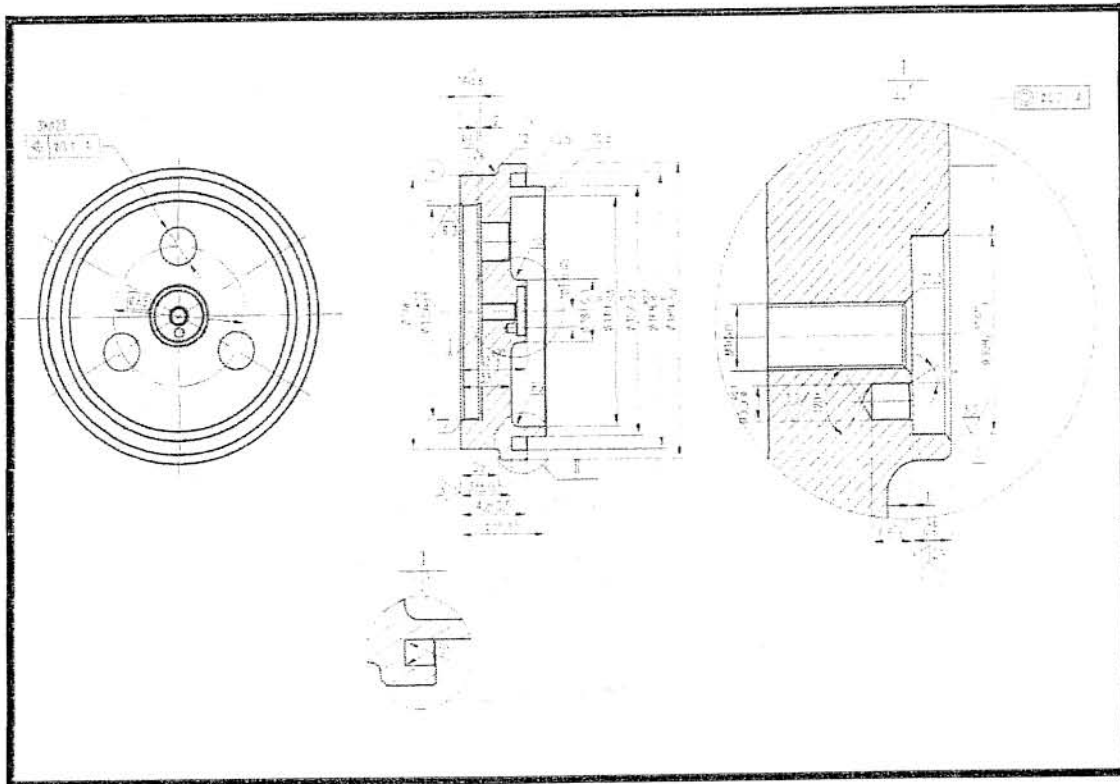

0044

F19 Front cover assembly of signal speed sensor

FOLIO
422

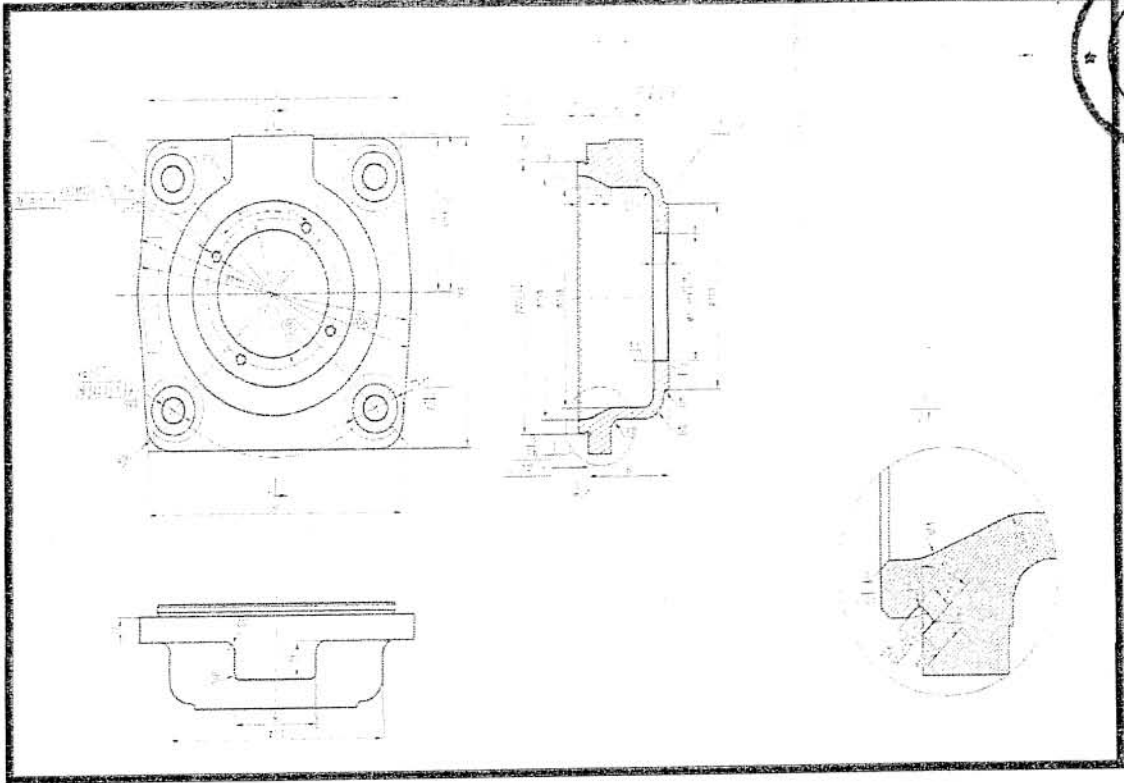

F20 Signal sensor cover

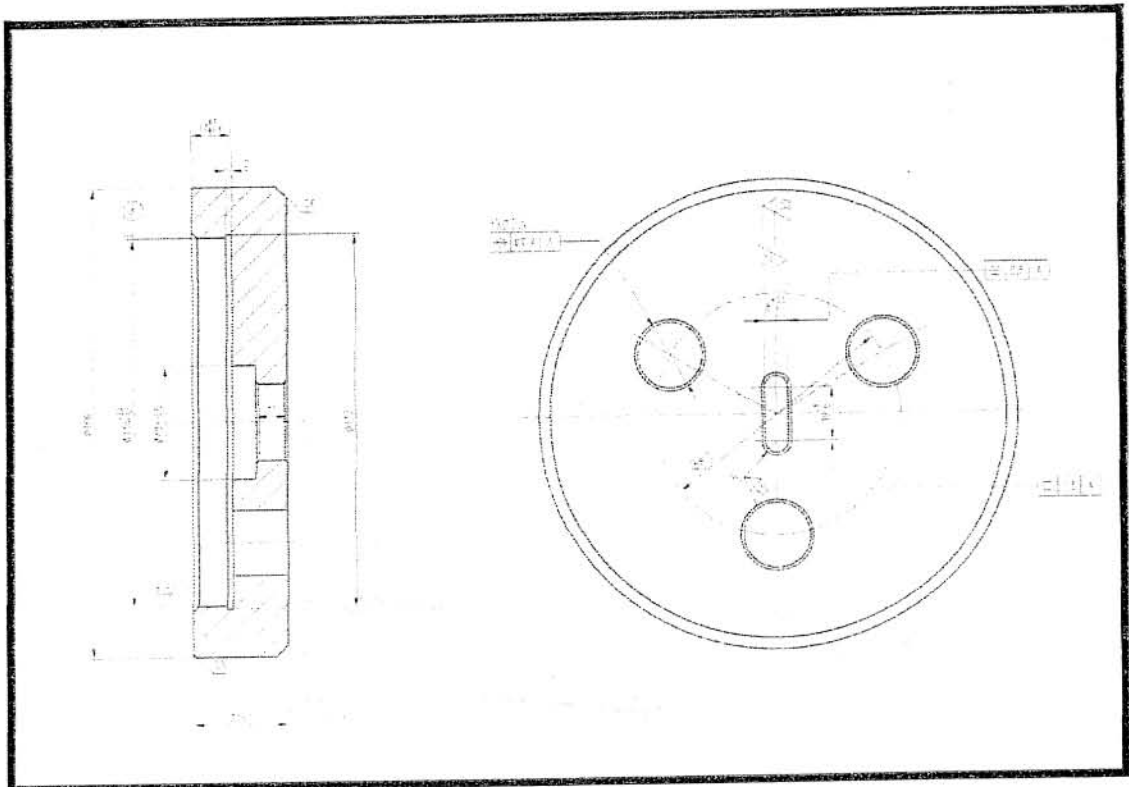

F21 Axle box body (right)

0044
FOLIO
423

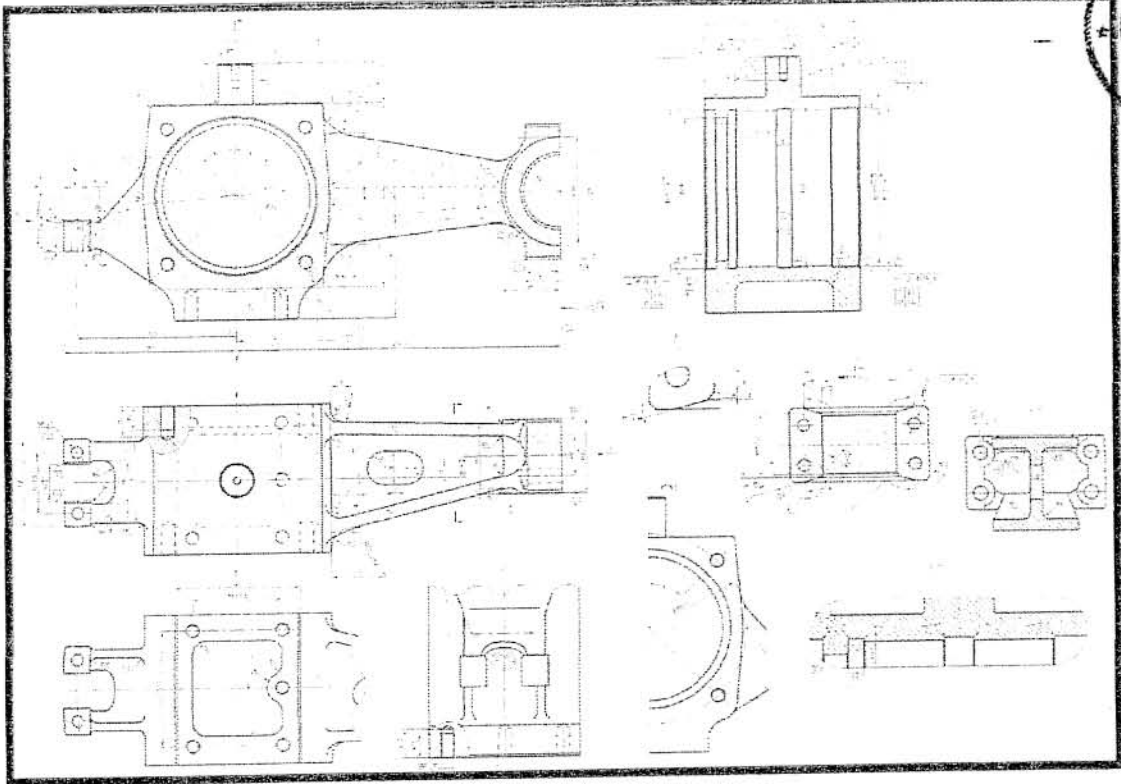

F22 Rear cover of axle box (1) left

